

PROSPECTUS

SCALE SALE

Sale Date: December 16, 2021

(1) Roseburg Sale No.: 2022.0016
Douglas County, Oregon: O&C: Sealed Bid

Sale Name: Conley Creek Fire Salvage
Bid Deposit Required: \$850.00

All timber designated for cutting on:

W $\frac{1}{2}$ NE $\frac{1}{4}$, SE $\frac{1}{4}$ NE $\frac{1}{4}$, S $\frac{1}{2}$ NW $\frac{1}{4}$, S $\frac{1}{2}$ Sec. 21, T. 25 S., R. 2 W., Willamette Meridian

Approx. Number	Est. Vol. MBF	Species	Est. Vol. MBF	Appraised Price	Est. Volume Times
Merch. Trees	32' Log		16' Log	Per MBF	Appraised Price
8,153	2,509	Douglas-fir	3,180	\$2.30	** \$7,314.00
2,516	409	Western Hemlock	527	\$1.30	** \$685.10
62	45	Sugar Pine	55	\$1.10	** \$60.50
471	30	Western Redcedar	41	\$3.10	** \$127.10
158	15	Incense-cedar	21	\$1.80	** \$37.80
5	1	Grand Fir	1	\$1.30	** \$1.30
11,365	3,009		3,825		\$8,225.80

*** This sale does not meet the OR/WA BLM minimum price policy of 10% of pond value. The State Director has given approval to sell this timber sale at 0.42% of pond value, with deficit/surplus adjustments.*

SEALED BIDS WILL BE RECEIVED BY THE DISTRICT MANAGER, OR DESIGNATED REPRESENTATIVE BY MAIL OR APPOINTMENT. MAIL SEALED BIDS TO THE BUREAU OF LAND MANAGEMENT ROSEBURG DISTRICT OFFICE, 777 NW GARDEN VALLY BLVD., ROSEBURG, OREGON 97471. CALL 541-440-4930, TO MAKE AN APPOINTMENT TO DROP OFF SEALED BIDS.

SEALED BIDS MUST BE RECEIVED BY 10:00 A.M., PST ON OR BEFORE THURSDAY, DECEMBER 16, 2021. BIDS WILL BE OPENED AND HIGH BIDDER WILL BE NOTIFIED BY EMAIL BY 4:30 P.M., PST.

SEALED BIDS SHOULD BE CLEARLY MARKED, **"ATTN: SEALED BID: CONLEY CREEK FIRE SALVAGE TIMBER SALE"**.

BIDDERS MUST SUBMIT A WRITTEN BID ON FORM 5440-9 ON A PRICE PER MBF AT A MINIMUM BID INCREMENT OF \$0.01 ON THE DOUGLAS-FIR SPECIES ONLY. THE BID MUST NOT BE LESS THAN THE APPRAISED PRICE OF \$2.30/MBF. ALL OTHER SPECIES WILL BE SOLD AT THE APPRAISED PRICE PER UNIT (MBF).

THE VOLUMES LISTED herein are estimates only, based on 16-foot taper breaks, which must be taken into consideration if comparisons are made with volume predictions based on other standards. The volumes based on 32-foot taper breaks are shown for comparison purposes. No sale shall be made for less than the total actual purchase price.

APPRAISED PRICES are determined by analytical appraisal methods unless otherwise noted on individual timber sale notices.

LOG EXPORT AND SUBSTITUTION RESTRICTIONS: All timber sales, including timber from Federal rights-of-ways, shall be subject to the restrictions relating to the export and substitution of unprocessed timber from the United States in accordance with P.L. 94-165 and 43 CFR 5400 and 5424 as amended.

Excepting Port-Orford-cedar, all timber offered for sale hereunder is restricted from export from the United States in the form of unprocessed timber and is prohibited from being used as a substitute for exported private timber.

CRUISE INFORMATION: For all Harvest Areas: the timber volumes for all tree species are based on a variable plot cruise, containing a total of 43 plots and 73 randomly selected sample trees. Plots were measured using a 20 basal area factor (BAF). The volume of the randomly selected sample trees has been expanded to a total sale volume. A map showing the location of the plots and sample trees is available at the Roseburg District Office.

With respect to merchantable trees of all species: the average tree is 18.4 inches D.B.H.O.B., the average log contains 105 bd. ft., the total gross volume is approximately 5,355 MBF and 71% recovery is expected.

CUTTING AREA: An area of approximately 163 acres distributed throughout 2 units will be salvaged.

TIMBER ACREAGE:

Area 1: 115 acres
Area 2: 48 acres

ACCESS: Access to the sale area is provided by Government and privately controlled roads.

DIRECTIONS TO SALE AREA: From Roseburg, proceed east on State Highway 138 (North Umpqua Highway) through the towns of Glide and Idleyld Park, approximately 22 miles, and turn left at the junction of County Road 78 (Rock Creek Access Road); proceed northeast on Rock Creek Access Road approximately 3 miles to the junction with Road 25-2-20.1 (Conley Creek Road) and follow the Exhibit D map to the sale area.

ROAD MAINTENANCE: Rockwear and maintenance fees required to be paid to the BLM are estimated at \$20,843.68; the final amount due will be adjusted based on the final scaled timber volume. Rockwear fees required to be paid to FIA Timber Growth Master LLC are estimated at \$700.90; the final amount due will be adjusted based on the final scaled timber volume. Rockwear fees required to be paid to Lone Rock TT LandCo LLC are estimated at \$307.30; the final amount due will be adjusted based on the final scaled timber volume.

ROAD CONSTRUCTION: Estimates include the following: renovate 138+30 stations of road. Additional information is available in Exhibit C and Exhibit D of the Timber Sale Contract.

DURATION OF CONTRACT will be **12 months** for cutting and removal of timber. The contract will contain SPECIAL PROVISIONS regarding: logging; road construction, renovation, maintenance, and use; environmental protection; fire prevention; slash disposal; log exports; and safety.

ADDITIONAL INFORMATION: This prospectus includes maps and tables that cannot be made Section 508 compliant. For help with its data or information, please contact the Roseburg District Office at 541-440-4930.

NOTES:

1. A revised Special Provision has been added to the contract which enables the Contracting Officer to suspend the contract to facilitate protection of certain plant or animal species, and/or to modify or terminate the contract when necessary to: (1) Comply with the Endangered Species Act or to prevent incidental take of northern spotted owls in accordance with management direction in the Record of Decision (ROD) and Resource Management Plan (RMP), or; (2) Comply with a stay or remedy issued by the Interior Board of Land Appeals or a court order, or; (3) Protect species which were identified for protection in accordance with management direction established in the ROD and RMP.
2. Seasonal restrictions apply to this sale regarding logging operations and use of native surfaced roads. Refer to Sections 42(A)(5)(b), 42(A)(9), 42(B)(2) and 42(C)(3)(c) for details. A “seasonal restriction matrix” is included with this prospectus to serve as a guide in planning and scheduling operations.
3. License agreements with FIA Timber Growth Masters LLC and Lone Rock TT LandCo, LLC are required. The terms and conditions of the license agreements are available for inspection at the Roseburg District Office.
4. For Harvest Area 2, this contract contains a special provision requiring the cutting and removal of timber to be completed earlier than the cutting and removal rights accorded under Section 4 of the contract in order to expedite reconstruction of the Millpond and Lone Pine recreation sites during the summer of 2022. Refer to Section 42(A)(7)(d) for details.
5. For all landings in Harvest Area 1 and the primary helicopter log landing for Harvest Area 2 located north of the Rock Creek Shop, slash disposal requirements consist of the following: machine piling, covering and burning slash and debris within a fifty (50) foot radius of landings. Refer to Section 42(E) for details.

For the secondary helicopter log landing for Harvest Area 2 located in the parking area adjacent to Lone Pine campground, end haul removal of all slash and debris will be required. Refer to Section 42(A)(7)(c) for details.

6. Simultaneous use of the contract area has been authorized along Road 25-2-20.1, Road 25-2-28.0, Road 25-2-33.1, and Road 25-2-27.1—hazard tree clearing is on-going and the logs have been sold pursuant to the Conley Creek Hazard Trees timber sale contract. Approximately 1 acre in Salvage Area 1 will be affected. Some coordination and scheduling with Future Logging may be beneficial in order to ensure maximum efficiency of both operations.

THIS IS A SALE PROSPECTUS ONLY. ATTACHMENTS MAY NOT INCLUDE ALL EXHIBITS REFERRED TO IN THE CONTRACT PROVISIONS. THE COMPLETE CONTRACT, INCLUDING ALL EXHIBITS, IS AVAILABLE FOR INSPECTION AT THE ROSEBURG DISTRICT OFFICE.

Section 41. TIMBER RESERVED FROM CUTTING -The following timber in the Contract Area is hereby reserved from cutting and removal under the terms of this contract and is retained as the property of the Government.

- (a) All timber on the Reserve Areas and all orange painted and posted trees and snags which mark the boundaries of the Reserve Areas, as shown on Exhibit A.
- (b) All trees and snags marked with orange paint above and below stump height within the Harvest Areas, as shown on Exhibit A. Reserved trees and snags which pose a hazard to operations may be felled with the approval of the Authorized Officer.
- (c) All sound, green trees within the Harvest Areas as shown on Exhibit A.
- (d) All downed trees and snags classified as decay Classes 3, 4, and 5 within the Harvest Areas as shown on Exhibit A. Decay classes are illustrated on Exhibit E which is attached hereto and made a part of hereof. Reserved trees and snags which pose a hazard to operations may be felled with the approval of the Authorized Officer.

Section 42. The Purchaser shall comply with the special provisions which are attached hereto and made apart hereof, unless otherwise authorized in writing by the Authorized Officer.

Section 42(A) Logging:

- (1) Before beginning operations on the Contract Area for the first time or after a shutdown of ten (10) or more days, the Purchaser shall notify the Authorized Officer in writing of the day they plan to begin operations. The Purchaser shall also notify the Authorized Officer in writing if they intend to cease operations for any period of ten (10) or more days.

In addition, the Purchaser shall notify the Authorized Officer five (5) days prior to starting or stopping of hauling operations performed under the contract.

- (2) Prior to the commencement of operations, the Purchaser shall obtain from the Authorized Officer written approval of a written operations and logging plan commensurate with the terms and conditions of the contract which shall include measures needed to assure protection of the environment and watershed. A pre-work conference between the Purchaser's authorized representative and the Authorized Officer must be held at a location designated by the Authorized Officer before the logging plan will be approved. All logging shall be done in accordance with the plan developed by this provision.
- (3) In the Harvest Areas shown on Exhibit A, all trees designated for cutting which are within one hundred (100) feet of the Reserve Areas shall be felled and yarded away from these areas.
- (4) No yarding or log loading is permitted in or through the Reserve Areas as shown on Exhibit A, unless otherwise approved by the Authorized Officer, except where associated with helicopter yarding and helicopter log landings as shown on Exhibit A.
- (5) In the Harvest Areas shown on Exhibit A, all trees designated for cutting shall be manually felled, unless otherwise approved by the Authorized Officer. Portions of Harvest Area 1 may be felled mechanically using a feller-processor or feller-buncher with the approval of the Authorized Officer and in accordance with the following specifications:
 - (a) Mechanized felling operations shall generally be limited to slopes of thirty-five (35) percent or less.
 - (b) No mechanized felling shall be permitted between October 1 of one calendar year and July 15 of the following calendar year, both days inclusive, or other periods of unseasonably wet weather and soil moisture conditions, unless otherwise approved by the Authorized Officer.
 - (c) The feller-processor or feller-buncher shall be approved by the Authorized Officer prior to the start of mechanized felling operations. Only purpose-built carriers with boom-mounted felling heads may be approved. The purpose-built carrier may be of the articulated, rubber-tired design or the zero tail swing, leveling, track-mounted design.

- (6) In the portions of Harvest Area 1 which are designated for cable yarding as shown on Exhibit A (approximately 115 acres):
- (a) Yarding shall be done with a cable skyline system utilizing a mechanical slack-pulling carriage capable of maintaining a fixed position on the skyline while lateral yarding and having a lateral capability of seventy-five (75) feet. The carriage must not move during in-haul. The system shall have the capability to yard in multi-span configuration.
 - (b) The leading end of all logs shall be suspended free of the ground during yarding. Lift trees and/or intermediate support trees shall be employed where necessary to meet this requirement.
 - (c) All logs shall be yarded away from or parallel to streams as shown on Exhibit A.
 - (d) Prior to attaching any logging equipment to a reserve tree, the Purchaser shall obtain approval from the Authorized Officer and shall take precautions to protect the tree from damage as directed by the Authorized Officer.
- (7) In the portions of Harvest Area 2 which are designated for helicopter yarding as shown on Exhibit A (approximately 48 acres):
- (a) Yarding shall be done with a helicopter.
 - (b) Helicopter log and service landings shall be placed at the approximate locations shown on Exhibit A. Alternative landing sites identified by the Purchaser must be approved in writing by the Authorized Officer prior to use.
 - (c) All slash which accumulates at the "secondary log landing," as shown on Exhibit A and located in the recreation site parking area adjacent to Lone Pine Campground, shall be removed within thirty (30) days of the completion of yarding. The slash shall be relocated to and disposed of at the "primary log landing," as shown on Exhibit A, in accordance with Section 42(E) of this contract.
 - (d) Notwithstanding the provisions of Section 4 of this contract, the cutting and removal of timber from Harvest Area 2 and all associated helicopter landing clean-up shall be completed before April 15, 2022 in order to expedite the reconstruction of Millpond and Lone Pine recreation sites. This requirement may be waived if the Purchaser identifies and utilizes alternative landing sites not associated with the recreation areas.
- (8) In accordance with the requirements of Section 8 it has been determined that the sale of additional timber located in the Contract Area, as shown on Exhibit A, which is obstructing needed cable yarding corridors, hazardous to workers, needed for guyline, tail hold or tieback trees, and/or severely damaged from the normal conduct of felling or yarding operations is needed to meet all applicable State safety laws, codes or regulations. This timber must be cut or removed so that the Purchaser can continue active falling and yarding operations. The

Purchaser is, therefore, authorized to cut and remove such additional timber in accordance with the provisions of Section 8 of the contract; provided that:

- (a) Trees reserved for the tree improvement program and trees reserved for the wildlife habitat objectives under Section 41 of the contract are not included in the authorization.
- (b) The Purchaser shall identify each tree sold and cut in accordance with the provision by marking the cut surface of the stump and the bottom log immediately after falling with high visibility red paint. The stump shall be marked by flagging the location of the stump with plastic fluorescent pink ribbon hung within five (5) feet of the stump at eye level so that the stump can be visually located from a distance of not less than one hundred (100) feet.
- (c) The volume and value for such timber shall be determined by the Authorized Officer in accordance with Bureau of Land Management prescribed procedures and paid for by the Purchaser in accordance with Section 3(a) or 3(e) of the contract through a unilateral modification executed by the Contracting Officer.
- (d) No timber may be cut or removed under the terms of this provision until all contract payments required by Section 3(a) or 3(e) of the contract have been made.
- (e) The permission to cut and remove additional timber contained in this provision may be withdrawn by the Contracting Officer if the Authorized Officer determines that the Purchaser:
 - (1) Failed to properly mark any stump as designated in this provision.
 - (2) Failed to identify the location of any stump.
 - (3) Cut any tree that was reserved for tree improvement and/or wildlife habitat.
 - (4) Cut any tree in or adjacent to cable yarding corridors that was not necessary to facilitate cable yarding.
 - (5) Cut any reserve tree in or adjacent to skid trails that was not necessary to facilitate ground based yarding.
 - (6) Failed to properly segregate any pulled-over tree that was yarded to the landing.
 - (7) Cut any reserve tree that was not severely damaged (as defined during the pre-work conference) from felling and yarding operations.
 - (8) Cut more than the minimum number of trees necessary to properly serve as guyline anchor stumps.
 - (9) Cut or topped more than the minimum number of trees necessary to properly serve as tail hold trees.
 - (10) Cut more than the minimum number of trees necessary to properly serve as tie-backs for topped tail hold trees.
 - (11) Failed to maintain accurate and current (no more than twenty-four [24] hours old) documentation of additional timber cut and removed.

If the permission to cut and remove additional timber provision is withdrawn, the Authorized Officer shall deliver to the Purchaser a written notice that additional sale of timber under this special provision is no longer approved.

If the permission to cut and remove additional timber provision is withdrawn, the Purchaser shall inform the Authorized Officer at least two (2) working days prior to the need for cutting and yarding any guyline tree, tail hold tree, tie-back tree, danger tree, corridor tree, pulled over tree, and severely damaged tree. All sales of additional timber shall comply with Section 8 of the contract. The Contracting Officer may order the Purchaser, in writing, to suspend, delay, or interrupt all or any part of the work of this contract for the period of time that the Contracting Officer determines appropriate for the Government to safely measure and mark additional timber.

All cable yarding corridors and/or ground based equipment skid trails upon which timber may be cut and removed in accordance with this special provision must be needed for the removal of timber sold under this contract and shall be limited to the narrowest width necessary for the yarding of logs with minimum damage to reserved trees.

The Purchaser shall be liable for damages in accordance with Section 13 of the contract for any reserved timber cut or removed in violation of the terms of this special provision.

- (9) No logging activity or log hauling shall be conducted on unsurfaced roads between October 15 of one calendar year and May 15 of the following calendar year (wet season), both days inclusive, unless otherwise approved by the Authorized Officer.
- (10) The Purchaser shall brand clearly and legibly one end of all logs prior to the removal of timber from the Contract Area. One end of all branded logs to be processed domestically will be marked with a spot of highway yellow paint, unless otherwise directed in writing by the authorized officer.
- (11) The Purchaser shall not haul logs from the contract area on weekends; Memorial Day, Fourth of July, Labor Day, Thanksgiving, Christmas, and New Year's holidays; or outside the hours of 4:00 a.m. to 8:00 p.m. daily, unless otherwise approved in writing by the Authorized Officer or designated in the approved logging plan.
- (12) The Purchaser will be required to label with a permanent ink marker each load ticket with the corresponding unit or road number that the logs originated from, as shown on Exhibit A, as directed by the Authorized Officer.
- (13) For a distance of fifty (50) feet from the perimeter of each landing designated by the Authorized Officer, all logs more than eight (8) inches in diameter at the large end and longer than eight (8) feet in length shall be decked or windrowed at the location designated by the Authorized Officer, except logs sold and removed from the Contract Area. If a log or piece of log meeting or exceeding the above specifications is bucked and left in place, all portions of that log shall be yarded and decked at the above described location.

Section 42(B) Road Construction, Maintenance & Use:

- (1) Purchaser shall renovate Road 25-2-21.2 Segment A, Road 25-2-27.1 Segments A, B, C and D, Road 25-2-28.1 Segments A and B, and Spurs 1, 2, and 3.

Any required construction or renovation shall be completed in strict accordance with the plans and specifications shown on Exhibit C, which is attached hereto and made a part hereof. Any required construction or renovation of structures and roads shall be completed and accepted, in accordance with Section 18, prior to the removal of any timber, except right-of-way timber, over that road.

- (2) No road construction or renovation shall be conducted between October 15 of one calendar year and May 15 of the following calendar year, both days inclusive, or other periods of unseasonably wet weather and soil moisture conditions, unless otherwise approved by the Authorized Officer.
- (3) The Purchaser is authorized to use the roads listed and shown on Exhibit D, which are under the jurisdiction of the Bureau of Land Management for the removal of Government timber sold under the terms of this contract provided that the Purchaser pay the required maintenance and rockwear obligations described in Section 42(B)(4). Any road listed on Exhibit D and requiring improvement or renovation in Exhibit C of this contract shall be maintained by the Purchaser until receiving written acceptance of the construction or renovation from the Authorized Officer. The Purchaser shall pay current Bureau of Land Management maintenance and rockwear fees for the sale of additional timber under modification to the contract.
- (4) The Purchaser shall pay the Government a rockwear fee of \$0.73 per thousand board feet log scale per mile for the use of rock surfaced roads listed on Exhibit D and a road maintenance fee of \$0.92 per thousand board feet log scale per mile for the use of Road 26-3-1.0 Segment A (portion). The total rockwear and maintenance fees due shall be based upon volumes determined pursuant to Exhibit B of this contract and mileage of roads used as determined by the Authorized Officer. Prior to the use of such roads, the Purchaser shall give written notice to the Authorized Officer of the roads intended for use in the removal of timber purchased under this contract, together with an estimate of the volume to be hauled over such roads. The Authorized Officer shall establish an installment schedule of payment of the road maintenance and rockwear obligation. If it is determined by the Authorized Officer, after all merchantable timber has been cut and scaled, that the total maintenance and rockwear payments made under this contract exceed the total maintenance and rockwear payment due, such excess shall be returned to the Purchaser after such determination is made.
- (5) The Purchaser shall perform any required road repair and maintenance work on roads used by them, under the terms of Exhibit D of this contract.
- (6) The Purchaser also agrees that if they elect to use any other private road which is the subject of a right-of-way agreement with the Government for the removal of Government timber sold under the terms of this contract, the Purchaser shall request and agree to the modification of

this contract to provide for such use and for allowances for amortization of the Government's share of the capital investment of any such road.

IF OTHER THAN FIA TIMBER GROWTH MASTERS LLC PURCHASES:

- (7) In the construction, renovation or use of Road 25-2-20.1 Segment A and Road 25-2-27.1 Segments B and C, the Purchaser shall comply with the conditions, including but not limited to those set out below, of the Right-of-Way and Road Use Agreement R-540B, dated March 10, 1960, between the United States of America and FIA Timber Growth Masters LLC., available for inspection at the Bureau of Land Management, Roseburg District Office, 777 N.W. Garden Valley Blvd., Roseburg, Oregon 97471. These conditions include:
- (a) Prior to the use of said roads, the Purchaser shall furnish the Authorized Officer a copy of the executed license agreement.
 - (b) Payment of a of a rockwear fee of \$0.73 per thousand board feet log scale per mile for the use of Roads 25-2-20.1 Segment A and Road 25-2-27.1 Segments B and C.
 - (c) Payment of a road use fee in the amount of \$0.56 per thousand board feet log scale for the use of Road 25-2-20.1 Segment A (not to exceed the total deficit balance owed of \$18.86).
 - (d) Default by the Purchaser of said Right-of-Way and Road Use Agreement, or any License Agreement executed pursuant thereto, for failure to pay appropriate road use fees or road maintenance fees shall be considered a violation of this contract. The amount of unpaid fees shall be considered as the amount of damage suffered by the Government as a result of the violation of this provision.

IF FIA TIMBER GROWTH MASTERS LLC PURCHASES:

- (8) The Government is hereby granted the allowance listed here as payment towards the Government's share of the replacement cost of the following road(s) included in Right-of-Way and Road Use Agreement R-540B:

Agreement	Road	Estimated Volume (MBF)	Road Use Fee	Estimated Subtotal	Deficit Balance
R-540B	25-2-20.1 A	2500	\$0.56	\$1,400.00	\$18.86
Total Road Use Fees: to be determined based on final scaled volumes					

It is understood that the purchase price stated in Section 2 of this contract is the net price and no deductions will be made from the purchase price because of such allowances.

IF OTHER THAN LONE ROCK TT LandCo LLC PURCHASES:

- (9) In the construction, renovation or use of Road 25-2-20.1 Segment C and Road 25-2-28.1 Segment A, the Purchaser shall comply with the conditions, including but not limited to those set out below, of the Right-of-Way and Road Use Agreement R-617A, dated March 30, 1963, between the United States of America and Lone Rock TT LandCo LLC., available for inspection at the Bureau of Land Management, Roseburg District Office, 777 N.W. Garden Valley Blvd., Roseburg, Oregon 97471. These conditions include:
- (a) Prior to the use of said roads, the Purchaser shall furnish the Authorized Officer a copy of the executed license agreement.
 - (b) Payment of a rockwear fee of \$0.73 per thousand board feet log scale per mile for the use of Road 25-2-20.1 Segment C and Road 25-2-28.1 Segment A.
 - (c) Default by the Purchaser of said Right-of-Way and Road Use Agreement, or any License Agreement executed pursuant thereto, for failure to pay appropriate road use fees or road maintenance fees shall be considered a violation of this contract. The amount of unpaid fees shall be considered as the amount of damage suffered by the Government as a result of the violation of this provision.

Section 42(C) Environmental Protection:

- (1) In addition to the requirements set forth in Section 26 of this contract, the Purchaser shall clean road surfaces, cut banks, landings, ditch lines and culverts of all debris created by logging operations.
- (2) In addition to the requirements set forth in Section 26 of this contract, the Purchaser shall steam clean or pressure wash all logging and road building equipment, except logging trucks, prior to initial move-in, to minimize the likelihood of spreading noxious weeds and non-native plant species to the Contract Area. Equipment washing shall occur at a location approved by the Authorized Officer. Equipment will be visually inspected by the Authorized Officer prior to use. Any logging or road building equipment removed from the Contract Area during the duration of the contract must be steam cleaned or pressure washed before it is returned to the Contract Area. Cleaning shall be defined as removal of all dirt, grease, plant parts and material that may carry noxious weed seeds.
- (3) In addition to the requirements set forth in Section 26 of this contract, the Purchaser shall winterize all native surfaced roads used under Section 42(B)(1) or any portion thereof, in accordance with the plans and specifications shown on Exhibit D, and in accordance with the following stipulations:
 - (a) The Purchaser intends to use the native surfaced roads or portions thereof for more than a single operating season; or, circumstances require that the roads or portions thereof overwinter before decommissioning.

- (b) Winterizing shall consist of water-barring, blocking and mulching to the satisfaction of the Authorized Officer.
 - (c) Winterizing shall take place prior to the end of the operating season as described in Section 42(A)(9) of this contract, or as directed by the Authorized Officer.
- (4) Wherever excessive furrowing occurs on cable-yarding roads, the Purchaser shall hand water-bar roads and fill furrows with limbs or other organic debris as directed by, and to the satisfaction of, the Authorized Officer. Excessive furrowing, as defined for this section, shall mean soil gullyng or trenching deeper than 1 foot for more than 50 feet on slopes 60 percent or greater.
- (5) In order to promote long-term soil productivity and minimize the potential for erosion, the Purchaser shall take measures to ensure a minimum of 10 tons/acre coarse woody debris larger than 3" in diameter remain in the Harvest Areas when yarding is completed. The coarse woody debris shall be comprised of limbs, tops, and other unmerchantable material. Merchantable logs may be left in the Harvest Area only when necessary to meet the 10 ton/acre requirement, as determined by the Authorized Officer.
- (6) Where danger tree clearing occurs within twenty (20) feet of any stream:
- (a) Trees identified for cutting shall be "high-stumped" a minimum of two (2) feet above the root collar in order to catch and stabilize large, woody debris within and adjacent to the stream channel;
 - (b) Trees identified for cutting shall be felled and yarded away from the stream channel;
 - (c) Existing downed trees shall not be removed from the stream channel.
- (7) The Purchaser shall immediately discontinue specified construction or timber harvesting operations upon written notice from the Contracting Officer that:
- (a) Threatened or endangered plants or animals protected under the Endangered Species Act of 1973, as amended, may be affected by the operation, and a determination is made that consultation or reinitiation of consultation is required concerning the species prior to continuing operation, or;
 - (b) When, in order to comply with the Endangered Species Act, or to prevent incidental take of northern spotted owls in accordance with management direction in the Record of Decision (ROD) and Resource Management Plan (RMP), or to protect occupied marbled murrelet sites in accordance with management direction of the ROD and RMP, the Contracting Officer determines it may be necessary to modify or terminate the contract, or;

- (c) Federal proposed, federal candidate, Bureau sensitive or State listed species protected under BLM Manual 6840 - Special Status Species Management - have been identified, and a determination is made that continued operations would affect the species or its habitat, or;
- (d) When, in order to comply with a court order, which enjoins operations on the sale or otherwise requires the Bureau of Land Management to suspend operations, or;
- (e) When, in order to comply with a court order, the Contracting Officer determines it may be necessary to modify or terminate the contract, or;
- (f) When, in order to comply with a stay or other remedy issued by the Interior Board of Land Appeals (IBLA) the Contracting Officer determines it may be necessary to modify or terminate the contract, or;
- (g) Species have been discovered which were identified for protection in accordance with management direction established in the ROD and RMP, and the Contracting Officer determines that continued operations would affect the species or its habitat, or;
- (h) When, in order to protect species which were identified for protection in accordance with management direction established in the ROD and RMP, the Contracting Officer determines it may be necessary to modify or terminate the contract.

Those operations necessary for a safe removal of personnel and equipment from the Contract Area and those directed by the Contracting Officer, which are required in order to leave the Contract Area in an acceptable condition will be permitted. Discontinued operations may be resumed upon receipt of written instructions and authorization by the Contracting Officer.

During any period of suspension, the Purchaser may withdraw performance and payment bond coverage aside from that deemed necessary by the Authorized Officer to secure cut and/or removed timber for which the Bureau of Land Management has not received payment, and/or unfulfilled contract requirements associated with harvest operations that have already occurred and associated post-harvest requirements.

In the event of a suspension period or a combination of suspension periods that exceed a total of thirty (30) days, the First Installment held on deposit may be temporarily reduced upon the written request of the Purchaser. For the period of suspension extending beyond thirty (30) days, the First Installment on deposit may be reduced to five (5) percent of the First Installment amount listed in Section 3(a) of the contract. Any First Installment amount temporarily reduced may be refunded or transferred to another BLM contract at the request of the Purchaser. However, if the Purchaser has outstanding debt owing the United States, the Contracting Officer must first apply the amount of First Installment that could be refunded to the debt owed in accordance with the Debt Collection Improvement Act, as amended (31 USC 3710, *et seq.*). Upon Purchaser's receipt of a bill for collection and written notice from the Contracting Officer lifting the suspension, the Purchaser shall restore the First Installment to the full amount shown

in Section 3(a) of the contract within fifteen (15) days after the bill for collection is issued, subject to Section 3(i) of the contract. The Purchaser shall not resume contract operations until the First Installment amount is fully restored.

In the event of a suspension period or a combination of suspension periods that exceed a total of thirty (30) days, the unamortized Out-of-Pocket Expenses for road or other construction required pursuant to Exhibit C of the contract shall be refunded or transferred to another BLM contract at the request of the Purchaser. Upon written notice from the Contracting Officer lifting the suspension, the Purchaser shall reimburse the Government the amounts refunded or transferred. The Purchaser may choose to pay this reimbursement at once or in installments payable at the same time as payments are due for the timber under the contract and in amounts approximately equal to the expenses associated with the timber for which payment is due.

In the event that a court-ordered injunction results in a suspension period in which the Purchaser loses operating time of 30 calendar days or more during the contract period, the Contracting Officer shall unilaterally modify the contract based on reappraisal of the remaining volume as of the date that the suspension is lifted. The 30 days can be the sum of days accruing during more than one operating season. Reappraisal may result in a decrease to the unit price bid per species. Reappraisal will be based on the loss of net volume due to the deterioration of logs during the period of delay and any associated changes in the amortization of logging costs per unit of volume, as determined by the Authorized Officer. Amortization of road construction cost over a reduced net volume will be considered as well as any additional move-in or logging costs caused by the delay, as determined by the Authorized Officer. Reappraisal will adjust Exhibit B volume and values, and will not consider changes in the market price of timber.

In the event that operating time is lost as a result of the incorporation of additional contract requirements, or delays due to Endangered Species Act consultation with the U.S. Fish and Wildlife Service or U.S. National Marine Fisheries Service, or court-ordered injunctions, or an IBLA issued stay or remedy, the Purchaser agrees that an extension of time, without reappraisal, will constitute a full and complete remedy for any claim that delays due to the suspension hindered performance of the contract or resulted in damages of any kind to the Purchaser.

The Contracting Officer may determine that it is necessary to modify the contract or terminate the cutting and removal rights under the contract in order to comply with the Endangered Species Act, prevent incidental take of northern spotted owls in accordance with the ROD and RMP, protect occupied marbled murrelet sites in accordance with the ROD and RMP, protect species that have been discovered which were identified for protection in accordance with management direction established in the ROD and RMP, or comply with a court order or an IBLA issued stay or remedy. Following the issuance of a written notice that cutting and removal rights will be terminated, the Purchaser will be permitted to remove timber cut under the contract, if allowed by the Endangered Species Act, if able to proceed without causing incidental take of northern spotted owls in accordance with the ROD and RMP, consistent with marbled murrelet occupied site protection in accordance with the ROD and RMP, if consistent with species protection in accordance with management direction established in the ROD and RMP, or if consistent with a court order or an IBLA issued stay or remedy.

In the event the contract is modified or cutting and removal rights are terminated under this subsection, the Purchaser agrees that the liability of the United States shall be limited to the actual costs incurred by the Purchaser which have not been amortized by timber removed from the Contract Area. This calculation of liability shall utilize actual Purchaser costs and Government estimates of timber volumes. At the Authorized Officer's request, the Purchaser agrees to provide documentation of the actual costs incurred in the performance of the contract. In addition, the Purchaser shall be released from the obligation to pay the contract price for any timber which is not authorized to be removed from the Contract Area.

The Purchaser specifically and expressly waives any right to claim damages, other than those described in the preceding paragraphs, based on an alleged breach of any duty to the Purchaser, whether express or implied, in regard to the manner in which the Government defended the litigation which resulted in the court order affecting the operation of the contract. This waiver also extends to any claims based on effects on the operation of the contract that arise from litigation against another agency. Furthermore, the Purchaser specifically acknowledges and agrees that a court ruling that the Government violated the Administrative Procedures Act cannot be interpreted, in itself, to mean that the Government had not acted reasonably in regard to its duties to the Purchaser under this contract.

Section 42(D) Fire Prevention and Control:

- (1) Primarily for purposes of fire prevention and control, the Purchaser shall, prior to the operation of power driven equipment in construction or logging operations under this contract during the closed fire season or periods of fire danger, prepare a fire prevention and control plan to the satisfaction of the Authorized Officer.

Section 42(E) Slash Disposal and Site Preparation:

- (1) Fire Hazard Reduction. In addition to the requirements of Section 15 of this contract, and notwithstanding the Purchaser's satisfactory compliance with state laws and regulations regarding offsetting or abating the additional fire hazard created by this operation and the State's willingness to release the Purchaser from liability for such hazard, the Purchaser shall remain responsible to the Government for performance of the following hazard reduction measures required by this contract:
 - (a) Slash, as defined for this section, shall mean all material (brush, limbs, tops, unmerchantable stems and chunks) severed or knocked over as a result of the Purchaser's operations under the terms of this contract.
 - (b) Landings shall be piled and covered within thirty (30) days of the completion of yarding from each landing.
 - (c) Covering of slash piles shall be done concurrently with piling operations. The covers shall be firmly fixed to each pile.

- (d) Finished piles shall be tight and free of earth.
- (e) Machine pile and cover all slash within fifty (50) feet of all landings or other locations as directed by the Authorized Officer in accordance with the following specifications:
 - (1) Landing slash piles shall be capped with a ten (10) foot by ten (10) foot cover of four (4) mil black plastic to maintain a dry ignition point.
 - (2) Slash piles shall be located away from unit boundaries, retention trees, snags, downed logs and stumps.
- (2) Notwithstanding the provisions of Section 15 of this contract, the Government shall assume all obligations for disposal or reduction of fire hazards created by the Purchaser's operations on Government lands, except for burning and mop-up assistance as required herein. In accordance with written instructions to be issued by the Authorized Officer at least ten (10) days in advance of the earliest date of required performance, the Purchaser shall, under supervision of the Authorized Officer or designated representative, assist in preparing units for burning, mop-up and patrol by furnishing, at the Purchaser's own expense, the services of personnel and equipment on each unit as shown below:

For igniting and burning landing piles in all Harvest Areas, the Purchaser shall provide one (1) eight (8) person hand crew including a designated crew foreman. The crew shall be equipped with fuel, ten (10) drip torches or propane burners, four (4) fire shovels, four (4) pulaskis, one (1) power saw and enough radios to facilitate inter-crew communications. All crew members must have a current qualification card for FFT2 or higher. All qualifications are defined according to National Wildfire Coordinating Group (NWCG) Wildland Fire Qualifications System guide, PMS 310-1. Qualifications and equipment levels are the minimum and may exceed those stated above.

Aircraft and pilots used for logging residue reduction or the suppression of escaped fires from logging residue reduction operations, shall be acquired from a list of aircraft and pilots approved (i.e. carded for these specific activities) by the Office of Aircraft Services or the U.S. Forest Service. This list is available from BLM District Offices upon request.

All listed personnel shall be physically fit, experienced and fully capable of functioning as required. All personnel shall arrive at the project area with the following personal safety equipment: lug-soled leather boots with minimum eight (8) inch uppers that provide ankle support; an approved hardhat; leather gloves; long pants and a long sleeve shirt made of approved aramid fabric (Nomex or equivalent); and an approved fire shelter.

All listed tools and equipment shall be in good usable condition. All power-driven equipment shall be fully fueled and available for immediate use. During periods of use under this subsection, the Purchaser shall provide fuel and maintenance for all such power-driven equipment. In addition, all listed personnel directly involved in burning operations shall be certified Fire Fighters qualified according to National Wildfire Coordinating Group (NWCG) Wildland Fire Qualification System guide, PMS 310-1 and provide documentation. The work

leaders must be fluent in English and be able to effectively speak to all crew members under their direction. Personnel who do not meet these requirements or who do not have proper clothing and personal protective equipment (PPE) will not be allowed to participate.

Except as provided hereafter for fire escapement, the Purchaser shall continue the required assistance in mop-up on each Harvest Area as shown on Exhibit A for seventy-two (72) hours as directed by the Authorized Officer within a thirty (30) day period beginning 8:00 a.m. the day following completion of ignition in that unit or until released from such services by the Authorized Officer, whichever occurs first.

In the event of a fire escapement, the Purchaser's personnel and equipment shall, under supervision of the Authorized Officer, take action to suppress, including control and mop-up, the escaped fire until released from such service by the Government. If it becomes necessary to suppress a fire which escapes from the prescribed fire area for a period beyond midnight of ignition day, then the Government shall, at its option:

- (a) Reimburse Purchaser for such additional use of personnel and equipment at wage rates shown in the current Administratively Determined Pay Rates for Western Area and at equipment rates shown in current Oregon-Washington Interagency Fire Fighting Equipment Rental Rates schedule, until the Purchaser is released from such service by the Government, or
- (b) Release the Purchaser from additional suppression work and assume responsibility for suppressing the escaped fire.

In situations where an escaped fire is controlled and contained by an adequate fire break (e.g., trail, road, stream, rock formation), the Government may permit the Purchaser to remove personnel for that day; provided that, all mop-up work on the escaped fire area is included with mop-up work on the prescribed fire area. In such an event, the Purchaser must sign a statement of agreement to complete mop-up work on all escaped fire areas concurrently with mop-up work on the prescribed fire area.

In case of injury to personnel or damage to equipment furnished by the Purchaser as required by this subsection, liability shall be borne by the Purchaser, unless such injury or damage is caused by Government negligence.

Time is of the essence in complying with this provision. In the event the Purchaser fails to provide the personnel and equipment required herein, the Purchaser shall be responsible for all additional costs incurred by the Government in disposing of slash including but not limited to the wages and other costs of providing federal employees and others as substitute labor force, the cost of providing substitute equipment and appropriate additional overhead expenses. If the Purchaser's failure results in a deferral of burning and new conditions necessitate additional site preparation work and/or use of additional personnel and equipment to accomplish planned burning, the Purchaser shall also be responsible for such additional costs.

Section 42(F) Log Exports:

- (1) All timber sold to the Purchaser under the terms of this contract, except exempted species, is restricted from export from the United States in the form of unprocessed timber, and is prohibited from being used as a substitute for exported private timber. For the purpose of this contract, unprocessed timber is defined as: (1) any logs except those of utility grade or below, such as sawlogs, peeler logs and pulp logs; (2) cants or squares to be subsequently remanufactured exceeding eight and three-quarters (8¾) inches in thickness; (3) split or round bolts or other roundwood not processed to standards and specifications suitable for end-product uses; or (4) western red cedar lumber which does not meet lumber of American Lumber Standards Grades of Number 3 dimension or better, or Pacific Lumber Inspection Bureau R-List Grades of Number 3 Common or better. Thus, timber manufactured into the following will be considered processed: (1) lumber and construction timber, regardless of size, manufactured to standards and specifications suitable for end-product uses; (2) chips, pulp and pulp products; (3) green or dry veneer and plywood; (4) poles and piling cut or treated for use as such; (5) cants, squares and lumber cut for remanufacturing of eight and three-quarters (8¾) inches in thickness or less; (6) shakes and shingles.

Substitution will be determined under the definition found in 43 CFR 5400.0-5(n).

The Purchaser is required to maintain and upon request to furnish the following information:

- (a) Date of last export sale.
- (b) Volume of timber contained in the last export sale.
- (c) Volume of timber exported in the past twelve (12) months from the date of last export sale.
- (d) Volume of Federal timber purchased in the past twelve (12) months from the date of last export sale.
- (e) Volume of timber exported in succeeding twelve (12) months from date of last export sale.
- (f) Volume of Federal timber purchased in succeeding twelve (12) months from date of last export sale.

In the event the Purchaser elects to sell any or all of the timber sold under this contract in the form of unprocessed timber, the Purchaser shall require each party buying, exchanging, or receiving such timber to execute a Form 5460-16 (Certificate as to Nonsubstitution and the Domestic Processing of Timber). The original of such certification shall be filed with the Authorized Officer. Additionally, when the other party is an affiliate of the Purchaser, the Purchaser will be required to update information under item (2) of Form 5450-17 (Export Determination) and file the form with the Authorized Officer.

In the event an affiliate of the Purchaser has exported private timber within twelve (12) months prior to purchasing or otherwise acquiring Federal timber sold under this contract, the Purchaser shall, upon request, obtain from the affiliate information in a form specified by the Authorized Officer and furnish the information to the Authorized Officer.

Prior to the termination of this contract, the Purchaser shall submit to the Authorized Officer Form 5460-15 (Log Scale and Disposition of Timber Removed Report) which shall be executed by the Purchaser. In addition, the Purchaser is required under the terms of this contract to retain for a three-year period from the date of termination of the contract the records of all sales or transfer of logs involving timber from the sale for inspection and use of the Bureau of Land Management.

Unless otherwise authorized in writing by the Authorized Officer, the Purchaser shall, prior to the removal of timber from the contract area, brand with the Purchaser's registered log brand at least one end of each bolt or other roundwood and identify each of these by painting with highway yellow paint.

In the event of the Purchaser's noncompliance with this subsection of the contract, the Authorized Officer may take appropriate action as set forth in Section 10 of this contract. In addition, the Purchaser may be declared ineligible to receive future awards of Government timber for a period of one year.

Section 42(G) Safety:

- (1) Purchaser's operations shall facilitate BLM's safe and practical inspection of Purchaser's operations and BLM's conduct of other official duties on Contract Area. Purchaser has all responsibility for compliance with safety requirements for Purchaser's employees, contractors and subcontractors.

In the event that the Authorized Officer identifies a conflict between the requirements of this contract or agreed upon methods of proceeding hereunder and State or Federal safety requirements, the contract may be modified. If the cost of such contract modification is of a substantial nature (\$2,000.00 or more), the Purchaser may request, in writing, an adjustment in the total contract purchase price specified in Section 2 of the timber sale contract, as amended, to compensate for the changed conditions.

Unless otherwise specified in writing, when operations are in progress adjacent to or on roads and/or trails in the harvest unit area, Purchaser shall furnish, install, and maintain all temporary traffic controls that provide the road or trail user with adequate warning of and protection from hazardous or potentially hazardous conditions associated with its operations. Purchaser shall prepare a Traffic Control Plan, which the Purchaser has determined is compliant with state and local OSHA and Transportation standards no later than the pre-work meeting and prior to commencing operations. Traffic control devices shall be appropriate to current operating and/or weather conditions and shall be covered or removed when not needed. Flagmen and devices shall be as specified in state OSHA and Transportation standards for logging roads or

Roseburg Sale No. 2022.0016
Sale Date: December 16, 2021
Conley Creek Fire Salvage

the "Manual on Uniform Traffic Control Devices for Streets and Highways" (MUTCD) published by the U.S. Department of Transportation – Federal Highway Administration. Included in the Traffic Control Plan, Purchaser shall note traffic control device locations on a Purchaser produced copy of the contract Exhibit "A" Map.

Seasonal Restriction Matrix

Note: This matrix is provided to serve prospective purchasers as a guide only; refer to the timber sale contract Special Provisions for a complete statement of the seasonal operating restrictions.

Seasonal Restriction 

Harvest Area	Activity	Jan		Feb		Mar		Apr		May		Jun		Jul			Aug			Sep		Oct		Nov		Dec	
		1	15	1	15	1	15	1	15	1	16	1	15	1	16	1	5	31	1	16	1	15	1	15	1	15	
Unit 1 (salvage)	Road renovation ¹																										
	Falling and bucking																										
	Cable yarding on rocked roads																										
	Loading or hauling on rocked roads																										
Unit 2 (salvage)	Falling and bucking																										
	Helicopter yarding																										
	Loading or hauling on rocked roads																										

¹Wet season restriction applying to use of unsurfaced (or limited strength) roads and all road construction/renovation from October 15 – May 15 may be shortened or extended depending on weather conditions.

UNITED STATES
DEPARTMENT OF THE INTERIOR
BUREAU OF LAND MANAGEMENT

Name of Bidder
Tract Number
Sale Name
Sale Notice <i>(dated)</i>
BLM District

DEPOSIT AND BID FOR: (Check One):

- Timber and/or Other Wood Products or**
(Examples of Other Wood Products: biomass, firewood, posts, poles, etc...)
- Vegetative Resources**
(Examples of Vegetative Resources: boughs, pinyon nuts, cones, plants, etc...)

<input type="checkbox"/> Sealed Bid for Sealed Bid Sale	<input type="checkbox"/> Written Bid for Oral Auction Sale
Time for opening sealed bids <input type="checkbox"/> a.m. <input type="checkbox"/> p.m.	Sale commences <input type="checkbox"/> a.m. <input type="checkbox"/> p.m.
On <i>(date)</i> Place	On <i>(date)</i> Place

In response to the above dated Sale Notice, the required deposit and bid are hereby submitted for the purchase of designated Timber and/or Other Wood Products or Vegetative Resources on the tract specified above.

Required bid deposit is \$ _____ and is enclosed in the form of:

cash
 money order
 cashier's check
 certified check
 bank draft
 bid bond of corporate surety on approved list of the United States Treasury
 guaranteed remittance approved by the authorized officer.

IT IS AGREED That the bid deposit shall be retained by the United States as liquidated damages if the bid is accepted and the undersigned fails to execute and return the contract, together with any required performance bond and any required payment within 30 days after the contract is received by the successful bidder. It is understood that no bid for less than the appraised price on a unit basis per product and species will be considered. If the bid is rejected the deposit will be returned.

BID SCHEDULE – TIMBER AND/OR OTHER WOOD PRODUCTS OR VEGETATIVE RESOURCES

NOTE: Bidders should carefully check computations in completing the Bid Schedule

BID SUBMITTED					ORAL BID MADE	
PRODUCT & SPECIES	UNIT	ESTIMATED VOLUME OR QUANTITY	UNIT PRICE	TOTAL VALUE	UNIT PRICE	TOTAL VALUE
			X	=	X	=
			X	\$1.30 = \$685.10	X	=
			X	\$1.10 = \$60.50	X	=
			X	\$3.10 = \$127.10	X	=
			X	\$1.80 = \$37.80	X	=
			X	\$1.30 = \$1.30	X	=
			X	=	X	=
			X	=	X	=
			X	=	X	=
			X	=	X	=
TOTAL PURCHASE PRICE						

If sale contract is executed, undersigned is liable for total purchase price including all modifications executed under the terms of the contract. Timber and/or Other Wood Products or Vegetative Resources designated for taking may be less or more than total estimated volume or quantity shown above. Undersigned certifies bid was arrived at by bidder or offeror independently, and was tendered without collusion with any other bidder or offeror. In submitting or confirming this bid, undersigned agrees to the foregoing provisions, applicable regulations, and certifies that he is authorized to act as, or on behalf of, the bidder.

Bid submitted on *(date)*

(Check appropriate box, sign in ink, and complete the following)

<input type="checkbox"/> Signature, if firm is individually owned	Name of firm <i>(type or print)</i>
<input type="checkbox"/> Signatures, if firm is a partnership or L.L.C.	Business address, include zip code <i>(type or print)</i>
<input type="checkbox"/> Corporation <u>organized</u> under the state laws of	<i>(To be completed following oral bidding)</i>
Signature of Authorized Corporate Signing Officer	I HEREBY confirm the above oral bid By <i>(signature)</i>
Title	Date
Submit bid, in <i>duplicate</i> , to qualify for either an oral auction or sealed bid sale together with the required bid deposit made payable to the Department of the Interior – BLM. Oral Auction – Submit to Sales Supervisor prior to closing of qualifying period for tract.	Sealed Bid – Send to District Manager, who issued the sale notice, in a sealed envelope marked on the outside: (1) “Bid for Timber and/or Other Wood Products or (1a) “Vegetative Resources ” (2) Time bids are to be opened (3) Legal description

NOTICES

The Privacy Act and the regulations in 43 CFR 2.223(d) require that you be furnished with the following information:

AUTHORITY: 38 FR 6280 and 43 CFR 5442.1

PRINCIPAL PURPOSE: To qualify an oral auction bidder, and then if successful, to bind bidder to certain contract conditions.

ROUTINE USES: To determine that an individual is qualified to participate in oral auction bidding, and, as surety that bidder will fulfill contract requirements.

EFFECT OF NOT PROVIDING INFORMATION: Filing this deposit and bid information is necessary only when an individual wishes to participate in a sealed or auction bid sale for Timber and/or Other Wood Products or Vegetative Resources.

INSTRUCTIONS TO BIDDERS

1. **AUTHORITY** – Timber and/or Other Wood Products or Vegetative Resources, located on the revested Oregon and California Railroad Grant Lands and on the reconveyed Coos Bay Wagon Road Grant Lands is administered and sold pursuant to authority of the Act of August 28, 1937 (50 Stat. 874; 43 U.S.C. 1181a); Timber and/or Other Wood Products or Vegetative Resources located on other public lands of the United States under jurisdiction of the Bureau of Land Management are administered and sold pursuant to authority of the Act of July 31, 1947 (61 Stat. 681), as amended, by the Act of July 23, 1955 (69 Stat. 367; 30 U.S.C. 601 et. seq.). Regulations of the Secretary of the Interior governing sale of Timber and/or Other Wood Products or Vegetative Resources, are codified in 43 CFR Group 5400.

2. **QUALIFICATIONS OF BIDDERS** – A bidder for sale of Timber and/or Other Wood Products or Vegetative Resources must be either (a) a citizen of the United States, (b) a partnership composed wholly of such citizens, (c) an unincorporated association composed wholly of such citizens, or (d) a corporation authorized to transact business in the State in which the Timber and/or Other Wood Products or Vegetative Resources are located.

3. **INSPECTION OF TIMBER AND/OR OTHER WOOD PRODUCTS OR VEGETATIVE RESOURCES** – Bidder is invited, urged, and cautioned to inspect the Timber and/or Other Wood Products or Vegetative Resources prior to submitting a bid. By executing the Timber and/or Other Wood Products or Vegetative Resources sale contract, bidder warrants that the contract is accepted on the basis of his examination and inspection of the Timber and/or Other Wood Products or Vegetative Resources and his opinion of its value.

4. **DISCLAIMER OF WARRANTY** – Government expressly disclaims any warranty of the fitness of the designated Timber and/or Other Wood Products or Vegetative Resources for any purpose of the bidder; all Timber and/or Other Wood Products or Vegetative Resources are to be sold “As Is” without any warranty of merchantability by Government. Any warranty as to the quantity or quality of Timber and/or Other Wood Products or Vegetative Resources to be sold is expressly disclaimed by Government.

5. **BIDS** – Sealed or written bids for not less than the advertised appraised price, per Timber and/or Other Wood Products or Vegetative Resources must be submitted in duplicate to the District Manager who issued *Timber and/or Other Wood Products or Vegetative Resources Sale Notice*.

(a) **Sealed Bid Sales** – Bids will be received until time for opening which is set out in the Notice. Enclose both copies of bid with required bid deposit in a sealed envelope marked on the outside *Bid for Timber and/or Other Wood Products or Vegetative Resources*, time bid is to be opened, tract number, and legal description of land on which Timber and/or Other Wood Products or Vegetative Resources are located. In event of a tie, the high bidder shall be determined by lot from among those who submitted the tie bids.

(b) **Auction Sales** – Submission of the required bid deposit and a written bid is required to qualify for oral bidding. Oral bidding shall begin from the highest written bid. No oral bid will be considered which is not higher than the preceding bid. In the event there is a tie in high written bids, and no oral bidding occurs, the bidder who was the first to submit his bid deposit and written bid shall be declared the high bidder. If the officer conducting the sale cannot determine who made the first submission of high tie written bids, the high bidder shall be determined by lot. High bidder must confirm his bid, in writing, immediately upon being declared high bidder.

(c) Except as otherwise provided in 43 CFR 5442.2, bids will not be considered in resale of Timber and/or Other Wood Products or Vegetative Resources remaining from an uncompleted contract from any person or affiliate of such person who failed to complete the original contract because of (1) cancellation for the purchaser’s breach or (2) through failure to complete payment by expiration date.

(d) When it is in the interest of the Government to do so, it may reject any and all bids and may waive minor deficiencies in bids or in sale advertisement.

6. **BID FORMS** – All sealed, written bids, and confirmation of oral bids shall be submitted on forms provided by Government.

(a) **Timber and/or Other Wood Products or Vegetative Resources Sales** – For each product and species, bids shall specify (1) Bureau of Land Management estimated unit volume or quantity, (2) bidder’s price per unit and total value, and (3) bidder’s total purchase price. Estimated volume and price per unit are to be used for administrative and appraisal purposes only. Upon award of contract, the high bidder agrees to pay the Government for the Timber and/or Other Wood Products or Vegetative Resources designated for removal in accordance with the terms of the contract. Timber and/or Other Wood Products or Vegetative Resources designated for taking may be less or more than total estimated volume or quantity shown above.

7. **BID DEPOSIT** – All bidders must make a deposit of not less than the amount specified in the *Timber and/or Other Wood Products or Vegetative Resources*

Notice. Deposit may be in the form of cash, money orders, bank drafts, cashiers or certified checks made payable to the Department of the Interior – BLM, bid bonds of a corporate surety shown on the approved list of the United States Treasury Department (*Applies To Timber Only*), or any approved guaranteed remittance approved by the Contracting Officer. Upon conclusion of bidding, the bid deposit of all bidders, except high bidder, will be returned. The cash deposit of the successful bidder may be applied toward the required sale deposit and/or the purchase price. Cash not applied to the sale deposit or the purchase price, or a corporate surety bid bond, will be returned at the time the contract is signed by the Government.

8. **AWARD OF CONTRACT** – Government may require high bidder to furnish such information as is necessary to determine the ability of bidder to perform the obligation of contract. Contract will be awarded to high bidder, unless he is not qualified or responsible or unless all bids are rejected. If high bidder is not qualified or responsible or fails to sign and return the contract together with required performance bond and any required payment, contract may be offered and awarded to the highest bidders qualified, responsible, and willing to accept the contract.

9. **TIMBER AND/OR OTHER WOOD PRODUCTS OR VEGETATIVE RESOURCES SALE CONTRACTS** – To be executed by purchaser, has been prepared by Government, and may be examined in the District or Field Manager’s office.

10. **PERFORMANCE BOND** – (*Primarily Used For Timber Sales*)

(a) A performance bond in an amount of not less than 20 percent of total purchase price is required, but the amount of the bond shall not be in excess of \$500,000, except when the purchaser opts to increase the minimum bond to permit cutting prior to payment as provided in 43 CFR 5451.2, or in the event the purchaser is a holder of an unresolved default the bond may be increased as provided in 43 CFR 5450.1(b). Performance bond may be (1) bond of a corporate surety shown on approval list issued by the United States Treasury Department and executed on an approved standard form, (2) personal surety bond executed on an approved standard form if Government determines principals and bondsman are capable of carrying out the terms of the contract, (3) cash bonds, (4) negotiable securities of the United States, or (5) any guaranteed remittance approved by the Contracting Officer.

(b) If purchaser elects to cut Timber and/or Other Wood Products or Vegetative Resources without skidding or yarding it to a loading point or removing it prior to the payment of the second or subsequent installments, Government shall require an increase in amount of performance bond initially required by an amount equal to the value of Timber and/or Other Wood Products or Vegetative Resources to be cut. Such increase must be on a bond rider form supplied by Government and be approved, in writing, by Government prior to cutting Timber and/or Other Wood Products or Vegetative Resources covered by the bond increase. This increased amount of bond shall be used to assure payment for Timber and/or Other Wood Products or Vegetative Resources cut in advance of payment.

11. **PAYMENT BOND**— (*Primarily Used For Timber Sales*)

If purchaser elects to (a) cut and remove Timber and/or Other Wood Products or Vegetative Resources, or (b) remove Timber and/or Other Wood Products or Vegetative Resources already cut which has been secured by an increased performance bond as provided in paragraph 10(b) above, before payment of the second or subsequent installments, Government shall require a payment bond on a form supplied by Government. Purchaser shall obtain written approval from Government of payment bond prior to cutting and/or removal of Timber and/or Other Wood Products or Vegetative Resources covered by the bond. Payment bond shall be used to assure payment for Timber and/or Other Wood Products or Vegetative Resources cut and/or removed in advance of payment.

12. **PAYMENT OF PURCHASE PRICE** – For sales of \$500 or more, Government may allow payment by installments. Except as discussed in paragraphs 10 and 11 above, no part of any Timber and/or Other Wood Products or Vegetative Resources sold may be severed, cut, or removed unless advance payment has been made as provided in contract.

13. **LIQUIDATED DAMAGES** – Within thirty (30) days from receipt of *Timber and/or Other Wood Products or Vegetative Resources Sale Contract*, the successful bidder shall sign contract and return it to Government, together with required bond and any required payment. If successful bidder fails to comply within the stipulated time, his bid deposit shall be retained by Government as liquidated damages.

14. **NINETY-DAY SALES** – If no bid is received within time specified in the advertisement of sale and if Government determines that there has been no significant rise in the market value of Timber and/or Other Wood Products or Vegetative Resources, it may, in its discretion, keep the sale open, not to exceed ninety (90) days.

15. *UNAUTHORIZED USE OF GOVERNMENT PROPERTY* – A sale may be refused to high bidder who has been notified that he has failed to make satisfactory arrangements for payment of damages resulting from unauthorized use of, or injury to, property of the United States.

16. *EQUAL OPPORTUNITY CLAUSE* – This contract is subject to the provisions of Executive Order No. 11246 of September 24, 1965, as amended, which sets forth the nondiscrimination clauses. Copies of this order may be obtained from the District Manager. 43 CFR 60-1.7(b) requires that the Equal Opportunity *Compliance Report Certification* will be completed by prospective contractors. Certification may be obtained from District Manager.

17. *LOG EXPORT* – All timber offered for sale except as noted in the *Timber Sale Notice* is restricted from export from the United States in the form of unprocessed timber and cannot be used as a substitute for exported private timber. For the purpose of this contract, unprocessed timber is defined as: (1) any logs except those of utility grade or below, such as saw logs, peeler logs, and pulp logs; (2) cants or squares to be subsequently remanufactured exceeding eight and three quarters (8-3/4) inches in thickness; (3) split or round bolts or other roundwood not processed to standards and specifications suitable for end product use; or (4)

western red cedar lumber which does not meet lumber of American Lumber Standards Grades of Number 3 dimensions or better, or Pacific Lumber Inspection Bureau R-List Grades of Number 3 common or better. Timber manufactured into the following will be considered processed: (1) lumber and construction timbers, regardless of size, manufactured to standards and specifications suitable for end product uses; (2) chips, pulp and pulp products; (3) green or dry veneer and plywood; (4) poles and piling cut or treated for use as such; (5) cants, squares, and lumber cut for remanufacture of eight and three quarters (8-3/4) inches in thickness or less; or (6) shakes and shingles. In event purchaser wishes to sell any or all of timber restricted from export in the form of unprocessed timber, the buyer, exchanges, or recipient shall be required to comply with contractual provisions relating to “*unprocessed timber*”. Special reporting, branding and painting of logs may be included in contract provisions.*

18. *DETAILED INFORMATION* – Detailed information concerning contract provisions, bid, performance bond forms, tract location maps, and access conditions may be obtained from the District Manager. All persons interested in bidding on the products listed are encouraged to familiarize themselves with all such detailed information.

Township 25 South, Range 2 West, Sections 21, Willamette Meridian

Salvage Area	Salvage Acres	Salvage Method
1	115	Cable
2	48	Helicopter
Totals	163	

Salvage Harvest Area.....	163 Acres
Reserve Area.....	357 Acres
Total Contract Area.....	520 Acres

1. Salvage Area boundaries are posted with tags that read "Boundary of Timber Reserve" and boundary trees are blazed and painted orange. Trees marked with orange blazes to delineate the boundaries of the Harvest Areas and trees marked with orange paint within the Harvest Areas are reserved by the government.
2. Salvage Area boundaries along existing roads, or within 150 feet of existing roads, are not posted or painted in order to allow for the clearing of danger trees along the roads.
3. Property lines are posted with orange and white tags that read "Timber Cutting Boundary".

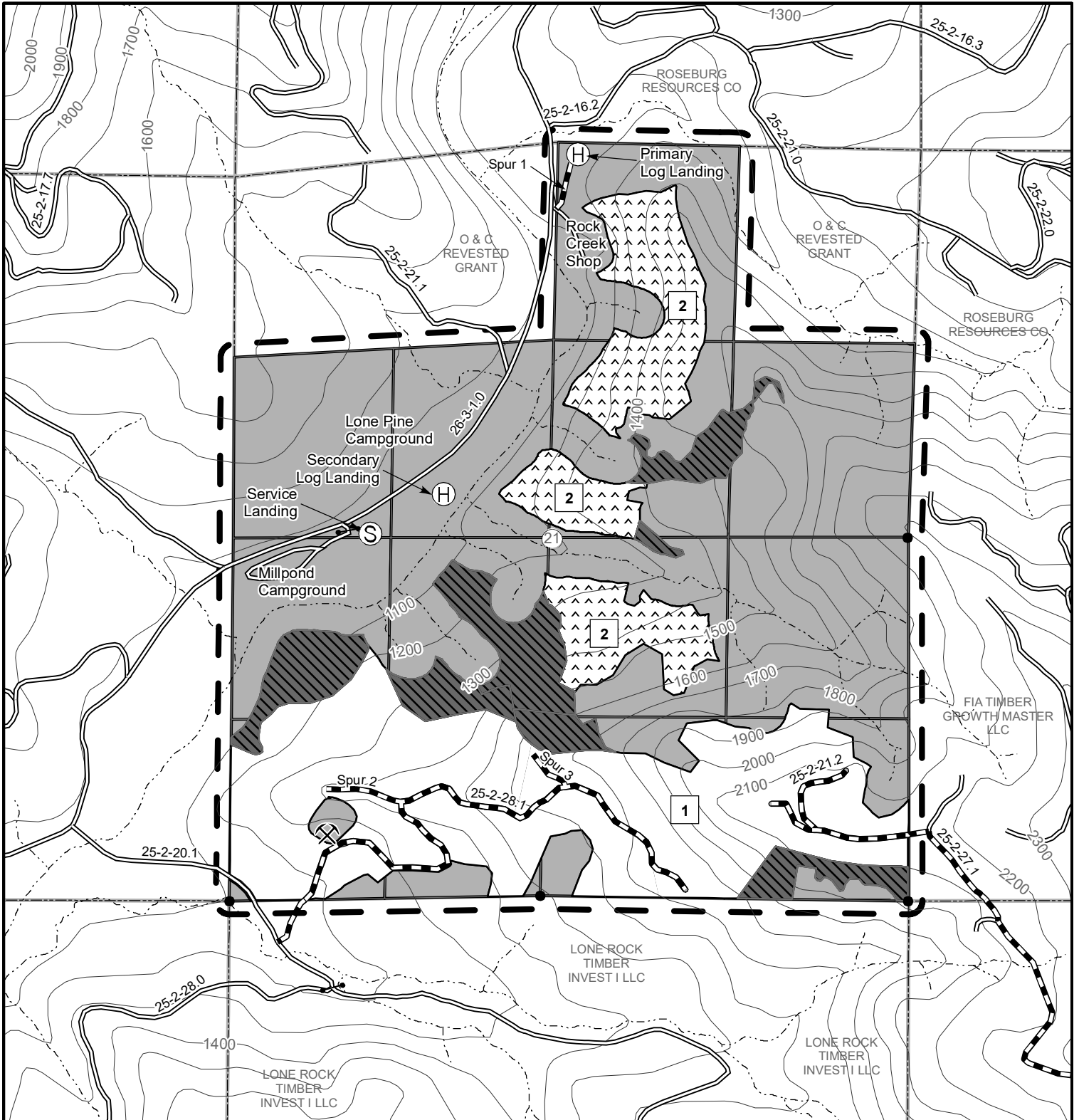

Legend

- Gate
- Rock Quarry
- Survey Corner
- Helicopter Service Landing
- Helicopter Log Landing
- Stream
- Existing Road
- Road Renovation
- Harvest Area - Cable
- Harvest Area - Helicopter
- Retention Aggregate
- Reserve Area
- Contract Area

1:12,000

1 inch = 1,000 feet

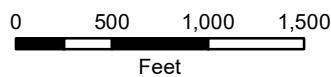

Date: 11/5/2021

Roseburg District
 Bureau of Land Management
 777 NW Garden Valley Blvd.
 Roseburg, Oregon 97471



No warranty is made by the Bureau of Land Management as to the accuracy, reliability, or completeness of these data for individual or aggregate use with other data. Original data were compiled from various sources and may be updated without notification.

**UNITED STATES
DEPARTMENT OF THE INTERIOR
BUREAU OF LAND MANAGEMENT (BLM)**

Contract No.:	ORR04-TS-2022.0016
Sale Name:	Conley Creek Fire Salvage
Issuing Office:	Roseburg District

**EXHIBIT B
SCALE SALE
PURCHASE PRICE SCHEDULE AND MEASUREMENT SPECIFICATIONS**

I. **Total Actual Purchase Price** - In accordance with Section 2 and 3 of the contract, the Purchaser agrees to pay the Government for the timber sold under the contract in accordance with the following schedule and measurement requirements. Timber sold is comprised of Merchantable Timber, Merchantable Timber Remaining, and Other Timber as defined below. In the event an Extension of Time is approved, the prices per measurement unit are subject to readjustment (refer to Section 9 of the contract).

Schedule of Species/Products, Measurement Units, and Prices		
Species/Products	Measurement Unit	Price Per Measurement Unit
Douglas-fir	MBF	\$2.30
Western Hemlock	MBF	\$1.30
Sugar Pine	MBF	\$1.10
Western Redcedar	MBF	\$3.10
Incense-cedar	MBF	\$1.80
Grand Fir	MBF	\$1.30

II. **Merchantable Timber** - All timber which can be cut into logs, which equal or exceed the following specifications, shall be considered merchantable timber required to be removed from the contract area. Purchaser shall pay for same in accordance with Section 3 of the contract at the unit prices shown in Section I of this Exhibit.

Schedule of Material Specifications			
Species/Product	Length (feet)	Diameter (inches inside bark at small end)	Net Scale (% of gross volume of any log segment)
All Species	16 feet	10 inches	33 1/3%

If Purchaser elects to remove any logs which do not meet the above minimum material specifications and which have not been reserved to Government in Sec. 41 of the contract, such logs shall be scaled in accordance with section V of this Exhibit herein and be paid for in accordance with Section 2 and 3 of the contract and the value in Section I of this Exhibit.

III. Merchantable Timber Remaining - Measurement Requirements - The remaining volume of any merchantable sold timber on the contract area shall be determined as provided in Section 3. (g). of the contract. Purchaser shall pay for same in accordance with Section 3 of the contract at the unit prices shown in Section I of this Exhibit.

IV. Other Timber - If any timber is of a species not listed in Section I of this Exhibit the Authorized Officer shall establish volumes and values in accord with Standard BLM methods.

V. Scaling

A. Log Rule and Measurement - All logs shall be scaled in Eastside Scribner according to the Northwest Log Rules Eastside and Westside Log Scaling Handbook, as amended, or supplemented by BLM before the first advertisement date of the sale.

B. Scaling Service - A Scaling Authorization Form must be completed and approved by the Authorized Officer prior to beginning of hauling operations. All sites on the Scaling Authorization are required to have a Log Yard Agreement with the BLM. Log scaling services shall be provided and performed by BLM personnel or third party scaling organizations under agreement with BLM.

1. All logs shall be scaled and volumes determined by BLM or a certified contract scaler.
2. The BLM scaler or contract scaler is designated to collect Eastside MBF scale data from all loads.
3. All logs shall be scaled using an authorized BLM scaling method approved by the Authorized Officer in accordance with BLM prescribed procedures.

C. Defect Caused by Abnormal Delay - Scaling deductions made for rot, check or other defect resulting from abnormal delay in scaling caused by Purchaser shall be recorded separately and charged to the Purchaser in accordance with Section 3 of the contract.

D. Log Presentation - Purchaser shall present logs so that they may be scaled in an economical and safe manner in accordance with the Log Yard Authorization required in Section V. B. of this Exhibit.

E. Check Scale

The BLM will conduct check scales using the following standards.

Gross Scale. A variance of one and ½ percent (1.5%) in gross scale is the standard unless otherwise justified.

Net scale. The allowable variance is as follows:

Check scaler's percent defect in logs	Scalers allowable variance
0-10 percent	2 percent
over 10 percent	0.2 * percent defect to a maximum of 5 percent

Determinations as to volume of timber made by a BLM check scaler in conformance with the standards as set forth herein shall be final. When such checks show a variance in scale in excess of acceptable standards, in two or more consecutive check scales, an adjustment to the volume reported as scaled will be made by BLM. Such adjustments will be made based on the difference between available BLM check scales and the original scale during the period covered by the unsatisfactory check scales. Unless otherwise approved in writing by the Authorized Officer, the volume to which this difference will be applied will be 50 percent of the volume scaled between the last satisfactory check and the first unsatisfactory check, 100 percent of the volume scaled during the unsatisfactory check, and 50 percent of the volume between the last unsatisfactory check scale and the next satisfactory check scale.

F. Accountability

1. Purchaser shall notify the Authorized Officer five (5) days prior to starting or stopping of hauling operations performed under the contract.
2. All logs will be painted and branded at the landing and accounted for in accordance with Section 42 of the contract. If Sale Area is within a State that maintains a log brand register, brands shall be registered with the State. Purchaser shall use assigned brand(s) exclusively on logs from this sale until the Authorized Officer releases the brand(s).
3. Each truck driver shall obtain a load receipt and a BLM scaler receipt from the Log Truck Ticket Book issued by the Authorized Officer and comply with the instructions specified on the cover of said book. All load tickets will be marked with the cutting area number using a permanent marker or as directed by the Authorized Officer. While products are in transit, the truck driver shall display the load receipt and BLM scaler receipt on the bunk or wing log at the front of the load on the driver's side. All logs on each load shall be delivered to the destination listed on the woods receipt. The BLM scaler receipt shall be surrendered at the location of BLM scaling, the unloading location, or as requested by BLM. A designated area shall be identified at

the yard scaling location for logs arriving during off hours. Logs arriving during off hours shall be left on the truck or may be off loaded to the designated area.

4. The Purchaser shall not haul logs from the contract area on weekends; Memorial Day, Fourth of July, Labor Day, Thanksgiving, Christmas, and New Year's holidays; or outside the hours of 4:00 a.m. to 8:00 p.m. daily, unless otherwise approved in writing by the Authorized Officer or designated in the Approved Logging Plan. (Refer to Section 42 of the contract).
5. The Purchaser shall furnish BLM a map showing the route which shall be used to haul logs from the timber sale area to the scaling location. Such route shall be the most direct haul route between the two points, unless another route is approved by BLM. The route of haul may be changed only with advance notice to and approval by BLM. The haul route map shall be attached to the Approved Logging Plan.
6. All loads will be scaled at locations listed on the Scaling Authorization as approved by the Authorized Officer. Purchaser shall notify the Authorized Officer five (5) days in advance to request additional scale site locations for approval on the Scaling Authorization.
7. Any removal of logs from loaded trucks before being accounted for and/or scaled as required by the contract shall be considered a willful trespass and render the Purchaser liable for damages under applicable law. Any payment made for purchase of such logs shall be deducted from amount due because of trespass.

G. **Scaling Lost Products** - The value of lost loads shall be equal to the highest value load for the month in which the lost load is hauled regardless of where the highest value load is scaled. If no loads have been scaled in that month, value will be determined from the closest month in which loads were scaled.

VI. **Estimated Volumes and Values** - The following volume estimates and calculations of value of timber sold are made solely as an administrative aid for determining payment amounts, when payments are due, the value of timber subject to any special bonding provisions, and other purposes specified in various portions of the contract. The cutting areas are shown on Exhibit A of the contract.

- A. **Merchantable Timber Volume Removed from Contract Area** - The total volume of removed timber shall be determined using the Government's records of scaled volumes of timber skidded or yarded monthly, or a shorter period if agreed to by the Purchaser and Government, to loading points or removed from the contract area.
- B. **Merchantable Timber Not Yet Removed from Contract Area** - The value of merchantable timber which has not been removed will be determined by multiplying the value per acre as shown below times the amount of acreage subject to the purpose of the value determination, as determined by the Authorized Officer:

**Total Estimated Purchase Price
And/or
Schedule of Volumes and Values for
Merchantable Timber Not Yet Removed from Contract Area**

Cutting Area		Total Estimated Volume (MBF)		Total Estimated Purchase Price	
Cutting Area Number	Approximate Number of Acres	Volume per Acre	Total Volume	Value per Acre	Total Value
Unit 1	115	23.5	2,700	\$50.49	\$5,805.90
Unit 2	48	23.4	1,125	\$50.41	\$2,419.90
Sale Total	163		3,825		\$8,225.80

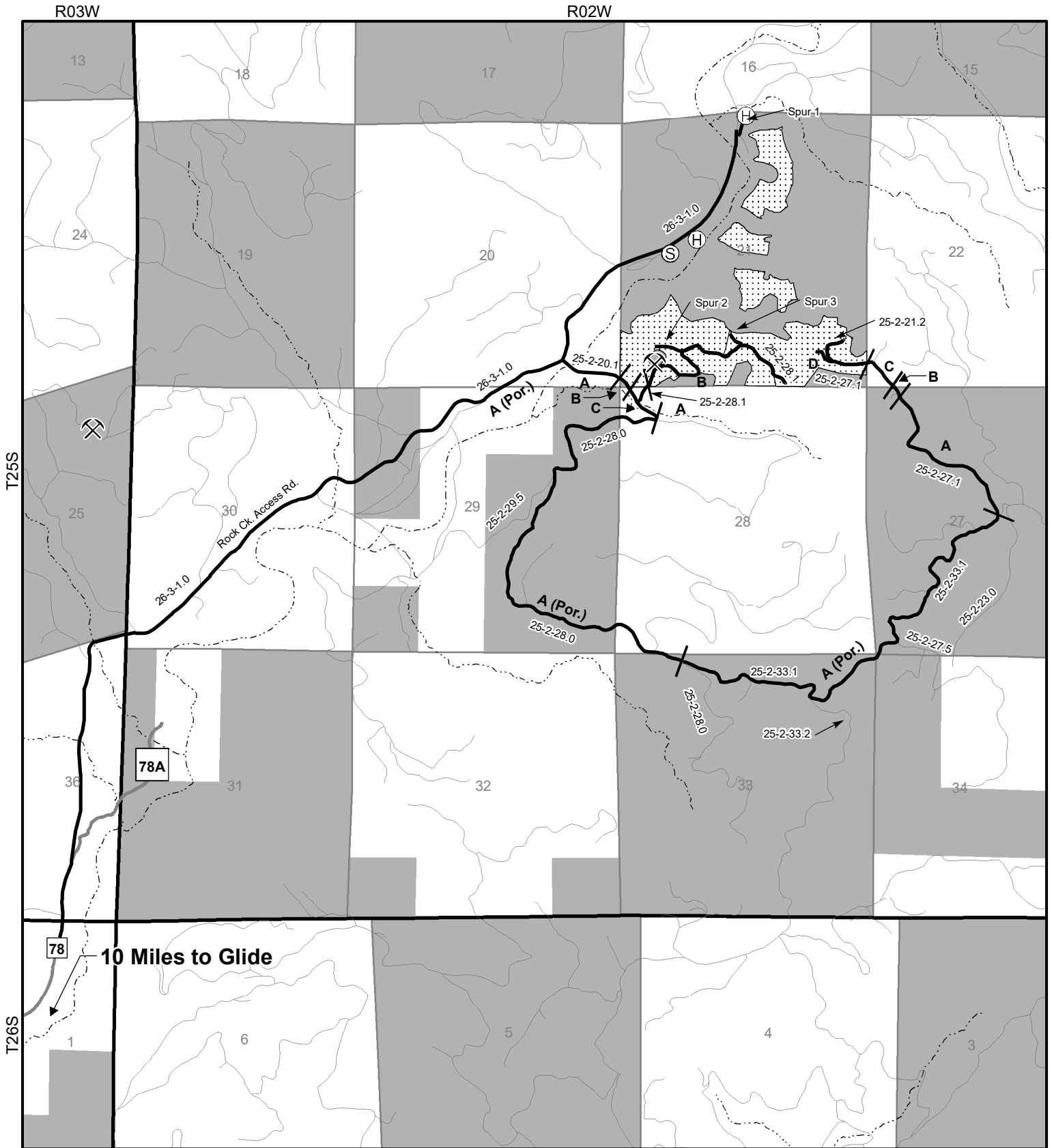

Legend

- ⊙ Service Landing
- ⊙ Heli. Log Landing
- ⊙ Rock Quarry
- Segment Breaks
- Existing Road
- Haul Route
- Major Stream
- ▨ Harvest Unit
- BLM Lands

1:31,680

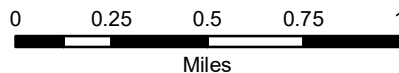

Date: 11/3/2021

Roseburg District
 Bureau of Land Management
 777 NW Garden Valley Blvd.
 Roseburg, Oregon 97471



No warranty is made by the Bureau of Land Management as to the accuracy, reliability, or completeness of these data for individual or aggregate use with other data. Original data were compiled from various sources and may be updated without notification.

**United States Department of the Interior
Bureau of Land Management Roseburg District
EXHIBIT D**

Sale Name: Conley Creek Fire Salvage

Contract No. ORR04-TS-2022.0016

Road Number	Road Seg.	Segment Length	Segment Owner	Road Use Fees	Surface Type	Timber Haul Fees*	Maintained By
* 25-2-20.1	A	0.24	TGM	\$0.56	Rock	\$0.73	Purchaser
25-2-20.1	B	0.05	BLM		Rock	\$0.73	Purchaser
25-2-20.1	C	0.12	LRTT	Paid Off	Rock	\$0.73	Purchaser
25-2-21.2	A	0.12	BLM		Rock	\$0.73	Purchaser
25-2-27.1	A	0.51	BLM		Rock	\$0.73	Purchaser
25-2-27.1	B	0.16	TGM	Paid Off	Rock	\$0.73	Purchaser
25-2-27.1	C	0.13	TGM	Paid Off	Rock	\$0.73	Purchaser
25-2-27.1	D	0.21	BLM		Rock	\$0.73	Purchaser
25-2-28.0	A (Por.)	1.94	BLM		Rock	\$0.73	Purchaser
25-2-28.1	A	0.06	LRTT	Paid Off	Rock	\$0.73	Purchaser
25-2-28.1	B	0.87	BLM		Rock	\$0.73	Purchaser
25-2-33.1	A (Por.)	1.85	BLM		Rock	\$0.73	Purchaser
26-3-1.0	A (Por.)	4.54	BLM		BST	\$0.92	BLM
Spur 1	A	0.09	BLM		Rock	\$0.73	Purchaser
Spur 2	A	0.11	BLM		Rock	\$0.73	Purchaser
Spur 3	A	0.07	BLM		Rock	\$0.73	Purchaser

* Total remaining Deficit of \$18.86 on 25-2-20.1 Seg. A will be paid off. w/ Haul on the 25-2-20.1 Seg. A on the Conley Creek Hazard Trees sale OR the Conley Creek Fire Salvage sale

ROAD MAINTENANCE SPECIFICATIONS

General road maintenance specifications are designated by numeric symbols according to the type of work performed as follows:

SECTION	DESCRIPTION
3000	General
3100	Operational Maintenance
3200	Seasonal Maintenance
3300	Final Maintenance
3400	Other Maintenance
3500	Decommissioning

ROAD MAINTENANCE SPECIFICATIONS

GENERAL - 3000

- 3001 The Purchaser shall be required to maintain all roads listed and/or referenced in section 42(B) Special Provisions of this contract in accordance with Sections 3000, 3100, 3200, 3300, 3400, and 3500 of this exhibit.
- 3002 The Purchaser shall maintain the cross section of existing dirt or graveled roads to the existing geometric standards. Any roads required to be constructed, improved, or renovated under terms of this contract shall be maintained to the geometric standards required in Exhibit C of this contract.
- 3003 The minimum required maintenance on any roads shall include the provisions specified in Subsections 3101, 3104, and 3105.
- 3004 The Purchaser shall be responsible for providing timely maintenance and cleanup on any roads with logging units substantially completed prior to moving operations to other roads. The maximum length of non-maintained or non-cleanup of the road prism shall not exceed the sum of one (1) mile at any time. Release of maintenance requirements may be granted, upon written request, when the conditions specified in Sections 3300 and 3400 are met satisfactorily.

OPERATIONAL MAINTENANCE - 3100

- 3101 The Purchaser shall blade and shape the road surface and shoulders with a motor grader. Banks shall not be undercut. Back blading with tractors or similar equipment will be allowed only around landings and other areas when approved by the Authorized Officer.
- 3102 The Purchaser shall furnish and place 300 cu. yds. of aggregate, conforming to the requirements in Section 1000 of Exhibit C of this contract, on the roadway at locations and in the amounts designated by the Authorized Officer.
- This aggregate shall be used to repair surface failures and areas of depleted surface depth excluding damages covered by Section 12 of this contract. The aggregate shall be furnished, hauled, placed, spread and compacted by use of dump trucks, water trucks and motor grader or similar equipment.
- 3104 The purchaser shall perform other road cleanup including removal of debris, fallen timber, bank slough, and slides which can practicably be accomplished by a motor grader, rubber tired front end bucket loader, rubber tired backhoe, street sweeper, or comparable equipment, and by the use of hand tools.

ROAD MAINTENANCE SPECIFICATIONS

- 3104a Removal of bank slough and slide material includes placement of material at the nearest designated, suitable disposal site where material cannot erode into streams, lakes, or reservoirs or cause undue damage to road fill slopes which have been planted or mulched to control soil erosion as directed by the Authorized Officer.
- 3104b The Purchaser shall be responsible for removal of all slides or slough, up to fifteen station yards in quantity, at any one site. This work includes unlimited multiple sites on all roads required to be maintained by the purchaser.
- Prior to removal of any slough or slide material exceeding fifteen station yards at any one site, the Purchaser and the Authorized Officer or their Authorized Representatives shall agree in writing, in the field, to the quantity of material, method of disposal, and the disposal site. Work may commence immediately after agreement.
- Upon completion of agreed upon work, a reduction in timber sale purchase price will be made to offset the cost of the work, based on current BLM Road Cost Guide. Adjustments in purchase price for completed work shall be made as necessary and no less than once per year when actual work is ongoing.
- 3105 The Purchaser shall be responsible for maintaining normal flow in drainage structures. This includes cleaning out drainage ditches, catch basins, clearing pipe inverts of sediment and other debris lodged in the barrel of the pipe, and maintaining water dips and water-bars using equipment specified in Subsection 3104 and other culvert cleaning and flushing equipment.
- 3106 The Purchaser shall be responsible for repair and replacement of all materials eroded from road shoulders and fill slopes, up to fifteen station yards in quantity, at any one site. This work includes unlimited multiple sites on all roads required to be maintained by the Purchaser. Prior to repair and replacement of eroded material exceeding fifteen station yards at any one site, the Purchaser and the Authorized Officer or their Authorized Representatives shall agree in writing, in the field, to the quantity of material, borrow source and method of repair. Work may commence immediately after agreement.
- Upon completion of agreed upon work, a reduction in timber sale purchase price will be made to offset the cost of the work based upon current BLM Road Cost Guide. Adjustments in purchase price for completed work shall be made as necessary and no less than once per year when actual work is ongoing.
- 3107 The Purchaser shall cut or trim trees and brush which obstructs vision or prevents the safe passage of traffic along the traveled way when directed by the Authorized Officer.

ROAD MAINTENANCE SPECIFICATIONS

The Purchaser shall also cut trees or brush encroaching on the road prism that are a result of his activities or winter damage during the contract period. Disposal of such vegetative material shall be by scattering below the road.

- 3108 The Purchaser shall avoid fouling gravel or bituminous surfaces through covering with earth and debris from side ditches, slides or other sources. The Purchaser shall also avoid blading surfacing material off the running surface of the roadway.
- 3108a The Purchaser shall perform logging operations on gravel or bituminous roadways only where the locations have been marked on the ground and/or approved by the Authorized Officer. Upon completion of log haul, the road surface shall be swept clean of debris. Repair of the roads is not considered maintenance and shall be conducted at the Purchaser's expense.
- 3108b Any damage to gravel or bituminous roadways, as a result of logging operations, is not considered maintenance and shall be repaired at the Purchaser's expense.
- 3109 The maximum allowable rut depth on aggregate surfaced roads is 2". Roads with ruts exceeding this requirement shall be bladed and brought back into conformance with the typical sections shown in the drawings. Rut depth shall be measured by centering a minimum 3 foot long straightedge across the wheel rut maintaining contact with the aggregate at both ends of the straight edge. The rut depth shall be the distance measured between the bottom of the straight edge and the lowest point of the wheel rut.

SEASONAL MAINTENANCE - 3200

- 3201 The Purchaser shall perform preventative maintenance at the end of Purchaser's hauling each season and during non-hauling periods which occur between other operations on the contract area. This includes requirements specified in Section 3100.
- 3202 The Purchaser shall perform and complete maintenance specified in Sections 3000, 3100, and 3200 on all roads maintained by the Purchaser, prior to October 1 each year, except as specified in Subsection 3203, after initial commencement of construction or logging operations. Thereafter, all roads shall have continuous preventive maintenance and road cleanup until suspension of seasonal operations. This includes all roads used and not used during the proceeding operating seasons.
- 3203 The Purchaser shall complete road cleanup and maintenance, as specified in Section 3100, at the completion of logging operations on any roads located in an area separate from the area where logging activities will resume.

ROAD MAINTENANCE SPECIFICATIONS

3204 The Purchaser shall be responsible for performing post storm inspections and maintenance during the winter season to minimize erosion and potential road or watershed damage.

FINAL MAINTENANCE - 3300

3301 The Purchaser shall complete final maintenance and/or damage repairs on all roads used under the terms of their contract within thirty 30 calendar days following the completion of hauling or the expiration of the Purchaser's right to cut and remove timber and in accordance with Sec. 16(b) of this contract. This work shall include any maintenance and/or damage repairs specified in Sections 3000, 3100, and 3200 necessary to meet the conditions specified in Subsection 3002 and shall be executed in accordance with Subsection 3302 of this section.

The Authorized Officer may grant acceptance of Purchaser's maintenance responsibility in part where certain individual roads or road segments are no longer of any use to the Purchaser's remaining removal operations, providing that all contract requirements as specified under Sec. 16(b), Special Provisions, Sections 3000, 3100, 3200 and 3300 of the maintenance specifications have been completed and a relinquishment of cutting and removal rights on cutting units tributary to these roads is signed by the Purchaser. Request for partial acceptance must be submitted in writing by the Purchaser.

3302 The Purchaser shall perform final road maintenance only when weather or soil moisture conditions are suitable for normal maintenance equipment operations as determined by the Authorized Officer.

If final maintenance is delayed after the date required in Subsection 3301 of this contract by adverse soil moisture or unsuitable equipment operating conditions, the Purchaser will be notified by the Authorized Officer when soil moisture and equipment operating conditions are suitable. The Purchaser shall then be required to complete final maintenance within 30 days.

OTHER MAINTENANCE - 3400

3401 The Purchaser shall repair any damage to road surfaces that was specified under Subsection 3108. This repair includes restoring the roadway to the designed standard and replacement of surfacing with approved surface material. This repair is not limited to use of equipment specified in Subsection 3104.

3402 The Purchaser shall be permitted to remove ice and snow from roads authorized for use under this contract only when prior written approval has been secured from the Authorized Officer. The Purchaser shall submit a written request for permission to remove ice and snow in advance of the date operations are to begin.

ROAD MAINTENANCE SPECIFICATIONS

3405 Upon receiving written authorization for ice or snow removal, the Purchaser will perform the work according to the conditions and equipment requirements set forth in the authorization.

DECOMMISSIONING – 3500

3501 Decommissioning shall consist of removing culverts, installing water bars, placement of slash, and blocking road from access by vehicles. This work is required for road acceptance under Section 18 of this contract.

3503 Decommissioning shall be performed on existing roads in accordance with these specifications, and as shown on the Exhibit D Trench Barrier and Waterbar Details.

3506 Stockpiled slash shall be used to protect exposed areas created by the Purchaser's decommissioning operations described in these sections. Slash shall be uniformly spread and placed without bunching. The operation shall produce a dense, uniform mat. Where slash is not available exposed soil areas shall be stabilized in accordance with Section 1800.

3508 Protect areas treated with slash placement from damage by Purchaser traffic or construction equipment. Damaged areas shall be repaired by the Purchaser.

3509 Access shall be blocked with barricades as shown on the typical detail sheet at locations listed in Section 3503.

3511 Water barring shall be done on designated roadways, turnouts, disturbed areas, and landings.

3513 Water bars shall be installed across full width of roadway at the spacing shown on the Exhibit D Waterbar Detail sheet.

3514 Protection of exposed surfaces shall be accomplished by placement of slash described in Subsection 3506 or placement of soil stabilization material in accordance with Section 1800 on designated roadways landings, cut banks, fill slopes, and other areas disturbed by the purchaser's decommissioning operations in accordance with these specifications and as shown in the plans.

ROAD MAINTENANCE SPECIFICATIONS

EXHIBIT D
TRENCH BARRIER DETAIL

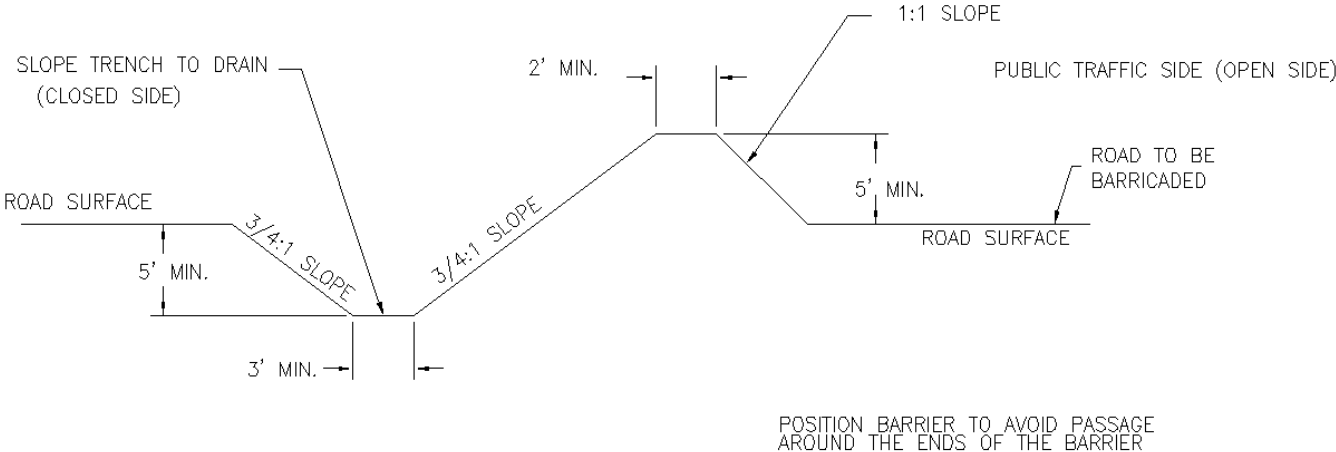

TRENCH BARRIER
SCALE: NONE

ROAD MAINTENANCE SPECIFICATIONS

EXHIBIT D
 WATERBAR DETAIL

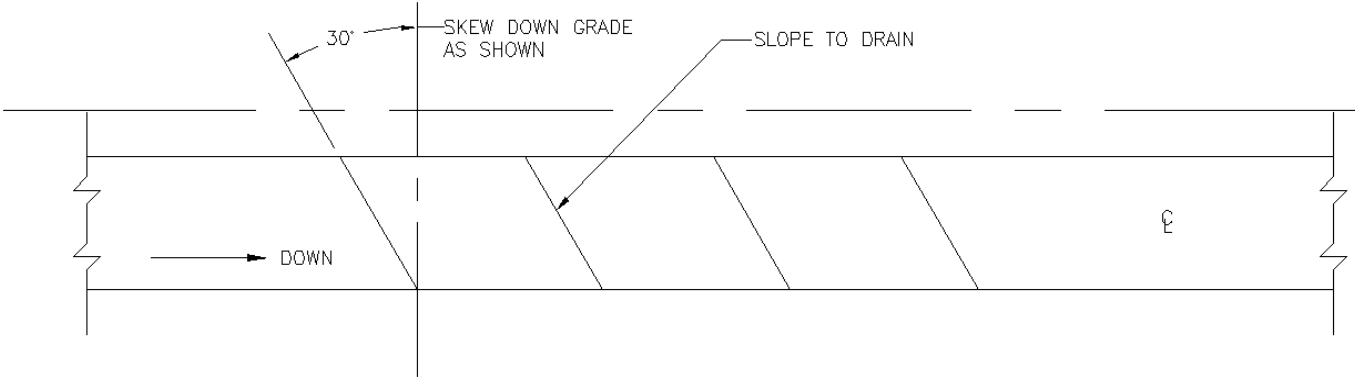

ROAD PLAN
 SCALE: NONE

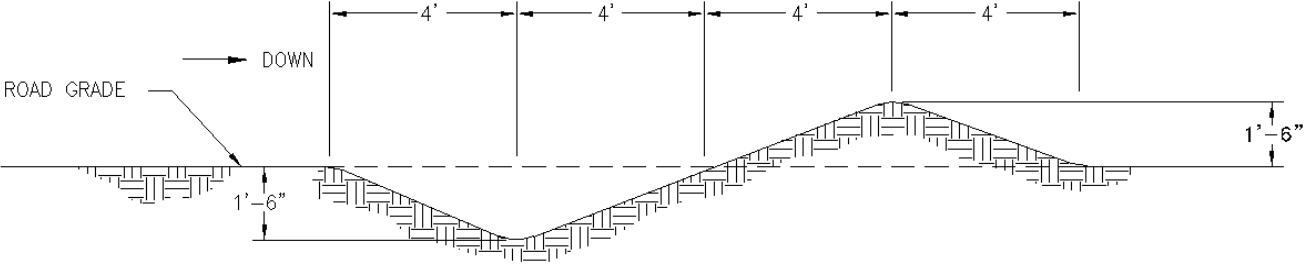



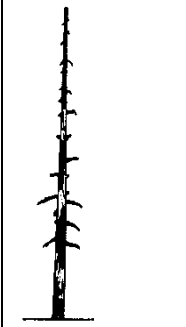
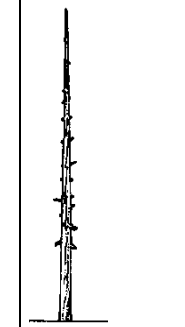
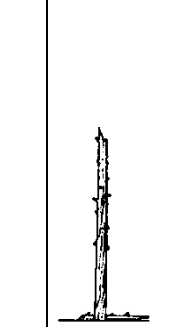
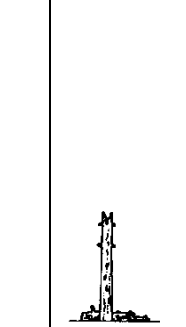

WATERBAR SPACING IN FEET	
ROAD GRADIENT IN %	SPACING
3 TO 5	300
6 TO 10	200
11 TO 15	150
16 TO 20	75
21 TO 35	50

ROAD PROFILE
 SCALE: NONE

Dead Tree Decay Classification

					
Class	1	2	3	4	5
Bark	Tight intact	50% loose or missing	75% Missing	75% Missing	75% Missing
Heartwood decay	Minor	None to advanced	Incipient to advanced	Incipient to advanced	Advanced to crumbly
Sapwood decay	None to incipient	Non to incipient	None to 25%	25% +	50% + advanced
Limbs	Mostly present	Small limbs missing	Few remain	Few remain	Absent
Top breakage	May be present	May be present	Approx. 1/3	Approx. 1/3-1/2	Approx. 1/2 +
Bole form	Intact	Intact	Mostly intact	Losing form, soft	Form mostly lost

Coarse Woody Debris Decay Classification

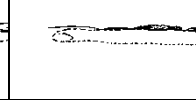
					
Class	1	2	3	4	5
Bark	Intact	Intact	Trace	Absent	Absent
Twigs	Present	Absent	Absent	Absent	Absent
Texture	Intact	Intact to soft	Hard, large pieces	Soft, blocky pieces	Soft, powdery
Shape	Round	Round	Round	Round to oval	Oval
Color of wood	Original	Original	Original to faded	Light brown to faded brown	Faded to light yellow or gray
Bole portion on ground	None, elevated on supports	Parts touch, still elevated	Bole on ground	Partially below ground	Mostly below ground



**United States
Department of the Interior
Bureau of Land Management**

Timber Appraisal

Sale Name: Conley Creek Fire Salvage	Sale Date: Thursday, December 16, 2021
BLM District: Roseburg DO	Unit of Measure: 16' MBF
Contract #: ORR04-TS-2022.0016	Contract Term: 12 months
Sale Type: Advertised	Contract Mechanism: 5450-4 Sale of Timber - Scale Sale

Content

Timber Appraisal Summary
Stumpage Summary
Unit Summary
Stump to Truck
Transportation
Engineering Allowances
Other Allowances

Prepared By: Kress, Christopher J - 11/24/2021

Approved By: Snider, Douglas A - 11/30/2021

Legal Description of Contract Area

Land Status	County	Township	Range	Section	Subdivision	Meridian
O&C	Douglas	25S	2W	21	W½NE¼, SE¼NE¼, S½NW¼, S½	Willamette

Species Totals

Species	Net	Gross Merch	Gross	# of Merch Logs	# of Cull Logs	# of Trees
Douglas Fir	3,180.0	4,238.0	4,409.0	38,320	4,677	8,153
Western Hemlock	527.0	708.0	763.0	8,485	1,910	2,516
Sugar Pine	55.0	74.0	75.0	354	30	62
Western Redcedar	41.0	68.0	71.0	1,234	193	471
Incense-cedar	21.0	35.0	35.0	546	0	158
Grandfir	1.0	2.0	2.0	17	3	5
Totals	3,825.0	5,125.0	5,355.0	48,956	6,813	11,365

Cutting Area Acres

Regeneration Harvest Acres	Partial Cut Acres	Right of Way Acres	Total Acres	Net Volume per Acre
163.0	0.0	0.0	163.0	23.5

Comments:

Timber is fire salvage from Archie Creek Fire 2020. This sale does not meet the OR/WA BLM minimum price policy of 10% of pond value. The State Director has given approval to sell this timber sale at 0.42% of pond value, with deficit/surplus adjustments.

Logging Costs

Stump to Truck	\$1,151,759.22
Transportation	\$279,015.00
Road Construction	\$189,101.11
Maintenance/Rockwear	\$39,060.21
Road Use	\$18.86
Other Allowances	\$2,575.00
Total:	\$1,661,529.40
Total Logging Cost per MBF:	\$434.39

Utilization Centers

Location	Distance	% of Net Volume
Roseburg, OR	27.4 miles	30 %
Roseburg, OR	26.3 miles	42 %
Roseburg, OR	31.3 miles	28 %

Profit & Risk

Profit	8 %
Risk	5 %
Total Profit & Risk	13 %

Tract Features

Quadratic Mean DBH	18.4 in
Average GM Log	105 bf
Average Volume per Acre	23.5 mbf
Recovery	71 %
<u>Net MBF volume:</u>	
Green	0.0 mbf
Salvage	3,825 mbf
Export	0 mbf
<u>Ground Base Logging:</u>	
Percent of Sale Volume	1 %
Average Yarding Slope	15 %
Average Yarding Distance	75 ft
<u>Cable Logging:</u>	
Percent of Sale Volume	70 %
Average Yarding Slope	55 %
Average Yarding Distance	500 ft
<u>Aerial Logging:</u>	
Percent of Sale Volume	29 %
Average Yarding Slope	55 %
Average Yarding Distance	1400 ft

Cruise

Cruise Completed	November 2021
Cruised By	SR, CK, JC
Cruise Method	
Variable plot cruised all merch species using a 20 BAF. 44 plots were cruised with a total of 73 sample trees.	

**UNITED STATES
DEPARTMENT OF THE INTERIOR
Bureau of Land Management**

District: Roseburg
Sale Number: ORR04-TS-2022.0016
Sale Name: Conley Creek Fire Salvage

Stumpage Computation

Species	Pond Value	Logging Costs (-)	Profit & Risk (-)	Marg. Logs (+)	Stumpage
Douglas Fir	\$538.50	\$434.39	\$70.01	\$0.00	\$34.11
W. Hemlock	\$294.92	\$434.39	\$38.34	\$0.00	(\$177.81)
Sugar Pine	\$245.46	\$434.39	\$31.91	\$0.00	(\$220.84)
W. Red Cedar	\$695.12	\$434.39	\$90.37	\$0.00	\$170.36
Incense Cedar	\$428.58	\$434.39	\$55.72	\$0.00	(\$61.53)
Grand Fir	\$304.00	\$434.39	\$39.52	\$0.00	(\$169.91)

Appraised Price Summary

Species	Volume	Unrounded Stumpage & Value		Adjusted Appraised Price	
		\$/M	Value	\$/M	Value
Douglas Fir	3,180.0	\$34.11	\$108,469.80	\$2.30	\$7,314.00
W. Hemlock	527.0	(\$177.81)	(\$93,705.87)	\$1.30	\$685.10
Sugar Pine	55.0	(\$220.84)	(\$12,146.20)	\$1.10	\$60.50
W. Red Cedar	41.0	\$170.36	\$6,984.76	\$3.10	\$127.10
Incense Cedar	21.0	(\$61.53)	(\$1,292.13)	\$1.80	\$37.80
Grand Fir	1.0	(\$169.91)	(\$169.91)	\$1.30	\$1.30
TOTALS	3,825.0				\$8,225.80

This sale does not meet the OR/WA BLM minimum price policy of 10% of pond value. The State Director has given approval to sell this timber sale at 0.42% of pond value, with deficit/surplus adjustments.

Approved by: DOUGLAS SNIDER Digitally signed by DOUGLAS SNIDER
Date: 2021.11.24 14:16:13 -08'00'
District Cruiser/Appraiser

Stumpage Computation

Species	# of Trees	Net Volume	Pond Value	(-) Profit & Risk	(-) Logging Costs	(+) Marginal Log Value	Appraised Price/MBF		Appraised Value
Douglas Fir	8,153	3,180.0	\$538.50	\$70.00	\$434.39	\$0.00	\$53.90	*	\$171,402.00
Western Hemlock	2,516	527.0	\$294.92	\$38.34	\$434.39	\$0.00	\$29.50	*	\$15,546.50
Sugar Pine	62	55.0	\$245.46	\$31.91	\$434.39	\$0.00	\$24.60	*	\$1,353.00
Western Redcedar	471	41.0	\$695.12	\$90.37	\$434.39	\$0.00	\$170.40		\$6,986.40
Incense-cedar	158	21.0	\$428.58	\$55.72	\$434.39	\$0.00	\$42.90	*	\$900.90
Grandfir	5	1.0	\$304.00	\$39.52	\$434.39	\$0.00	\$30.40	*	\$30.40
Totals	11,365	3,825.0							\$196,219.20

* Minimum Stumpage values were used to compute the Appraised Price/MBF (10% of Pond Value)

Percent of Volume By Log Grade

Species	No. 1 & 2 Peeler	No. 3 Peeler	Special Mill	No. 2 Sawmill	No. 3 Sawmill	No. 4 Sawmill	Camp Run
Douglas Fir				77.0 %	22.0 %	1.0 %	

Species	Peeler	No. 1 Sawmill	Special Mill	No. 2 Sawmill	No. 3 Sawmill	No. 4 Sawmill	Camp Run
Western Hemlock							100.0 %

Species	No. 1 Sawmill	No. 2 Sawmill	No. 3 Sawmill	No. 4 Sawmill	No. 5 Sawmill	No. 6 Sawmill	Camp Run
Sugar Pine							100.0 %

Species	No. 1 Sawmill	No. 2 Sawmill	No. 3 Sawmill	No. 4 Sawmill			Camp Run
Western Redcedar							100.0 %

Species	No. 1 Sawmill	No. 2 Sawmill	No. 3 Sawmill	No. 4 Sawmill	No. 5 Sawmill	No. 6 Sawmill	Camp Run
Incense-cedar							100.0 %

Species	Peeler	No. 1 Sawmill	Special Mill	No. 2 Sawmill	No. 3 Sawmill	No. 4 Sawmill	Camp Run
Grandfir							100.0 %

Unit: 1

Species	Net	Gross Merch	Gross	# of Trees
Douglas Fir	2,244.0	2,990.0	3,111.0	5,752
Western Hemlock	372.0	499.0	538.0	1,774
Sugar Pine	39.0	52.0	53.0	44
Western Redcedar	29.0	48.0	50.0	332
Incense-cedar	15.0	25.0	25.0	112
Grandfir	1.0	2.0	2.0	5
Totals:	2,700.0	3,616.0	3,779.0	8,019

Net Volume/Acre: 23.5 MBF

Regeneration Harvest	115.0
Partial Cut	0.0
Right of Way	0.0
Total Acres:	115.0

Unit: 2

Species	Net	Gross Merch	Gross	# of Trees
Douglas Fir	936.0	1,248.0	1,298.0	2,401
Western Hemlock	155.0	209.0	225.0	742
Sugar Pine	16.0	22.0	22.0	18
Western Redcedar	12.0	20.0	21.0	139
Incense-cedar	6.0	10.0	10.0	46
Totals:	1,125.0	1,509.0	1,576.0	3,346

Net Volume/Acre: 23.4 MBF

Regeneration Harvest	48.0
Partial Cut	0.0
Right of Way	0.0
Total Acres:	48.0

Comments:

GF volume added to sale taken from other whitewood, WH, due to pricing. Cruisers identified areas of GF in salvage sale, but were unable to capture it in plots.

Total Stump To Truck	Net Volume	\$/MBF
\$1,151,759.22	3,825.0	\$301.11

Stump to Truck: Falling, Bucking, Yarding, & Loading

Yarding System	Unit of Measure	# of Units of Measure	\$/Unit of Measure	Total Cost	Remarks
Helicopter	GM MBF	1,509.0	\$525.06	\$792,315.54	All Unit 2
Shovel	GM MBF	542.0	\$109.09	\$59,126.78	All Shovel Yarding
Cable: Medium Yarder	GM MBF	3,074.0	\$96.85	\$297,716.90	All Cable Yarding
Subtotal				\$1,149,159.22	

Additional Costs

Item	Unit of Measure	# of Units of Measure	\$/Unit of Measure	Total Cost	Remarks
Intermediate Support	Each	6.0	\$200.00	\$1,200.00	
Lift Tree	Each	14.0	\$100.00	\$1,400.00	
Subtotal				\$2,600.00	

Additional Moves

Equipment	Unit of Measure	# of Units of Measure	\$/Unit of Measure	Total Cost	Remarks
Subtotal				\$0.00	

Total	Net Volume	\$/MBF
\$279,015.00	3,825.0	\$72.95

Utilization Center	One Way Mileage	Description	Unit of Measure	# of Units	\$/Unit of Measure	Total Cost	% of Sale Volume
Roseburg, OR	27.4	From Midpoint of Heli landings	Hour	790.0	\$95.00	\$75,050.00	30 %
Roseburg, OR	26.3	From Spur 2 Unit 1	Hour	1,126.0	\$95.00	\$106,970.00	42 %
Roseburg, OR	31.3	From 25-2-21.2 Unit 1	Hour	1,021.0	\$95.00	\$96,995.00	28 %

Comments:

Trucking Summary: Topside Unit 1

Loads = 1,446 GM MBF/ 4.5 MBF/Ld = 322 Lds (Rounded)

RTM = (130 Min/Ld + 60 Min Delay) / 60 Min/Hr = 3.17 Hrs/Lds

3.17 Hrs/Ld X 322 Lds = 1,021 Total Hrs. (rounded)

1,021 Hrs X \$95/Hr = \$ 96,995.00 Transportation Cost

Trucking Summary: Helicopter Units

Loads = 1,509 GM MBF/ 4.5 MBF/Ld = 336 Lds (Rounded)

RTM = (81.2 Min/Ld + 60 Min Delay) / 60 Min/Hr = 2.35 Hrs/Lds

2.35 Hrs/Ld X 336 Lds = 790 Total Hrs. (rounded)

790 Hrs X \$95/Hr = \$ 75,050.00 Transportation Cost

Trucking Summary: Bottom side Unit 1

Loads = 2,170 GM MBF/ 4.5 MBF/Ld = 483 Lds (Rounded)

RTM = (80.0 Min/Ld + 60 Min Delay) / 60 Min/Hr = 2.33 Hrs/Lds

2.33 Hrs/Ld X 483 Lds = 1,126 Total Hrs. (rounded)

1,126 Hrs X \$95/Hr = \$ 106,970.00 Transportation Cost

Engineering Allowances

Total	Net Volume	\$/MBF
\$228,180.18	3,825.0	\$59.65

Cost Item	Total Cost
Road Construction:	\$189,101.11
Road Maintenance/Rockwear:	\$39,060.21
Road Use Fees:	\$18.86

Total	Net Volume	\$/MBF
\$2,575.00	3,825.0	\$0.67

Environmental Protection

Cost item	Total Cost
Equipment Cleaning	\$825.00
Subtotal	\$825.00

Slash Disposal & Site Prep

Cost item	Total Cost
Burn Landing Piles	\$350.00
Landing Piling/Covering	\$1,400.00
Subtotal	\$1,750.00

UNITED STATES
DEPARTMENT OF THE INTERIOR
BUREAU OF LAND MANAGEMENT

Version: 7.0.0.4
Updated: 11/20/2019

Summary of All Roads and Projects

T.S. Contract Name: Conley Creek Fire Salvage Tract No: 2022.0016 Sale Date: 12/16/2021
Prepared by: Radford Ph: Print Date: 11/15/2021 9:04:39 AM

Construction:	0.00 sta		
Improve:	0.00 sta	Renov:	138.30 sta
		Decom:	0.00 sta
		Temp:	0.00 sta
200 Clearing and Grubbing:	1.00 acres		\$1,856.29
300 Excavation:	50 cy		\$142.00
	Haul < 500 ft:	0 sta-yds	
	Haul > 500 ft:	0 yd-mi	
400 Drainage:			\$13,558.40
	Culvert:	0 lf	
		DownSpout:	0 lf
	PolyPipe:	320 lf	
500 Renovation:			\$3,572.93
	Blading	2.63 mi	
700-1200 Surfacing:			\$163,706.65
Commercial Quarry Name:	Shorts Quarry 1.5"	1,809 LCY	
Commercial Quarry Name:	Shorts Quarry 3"	2,811 LCY	
Commercial Quarry Name:	Shorts Quarry 6"	992 LCY	
1300 Geotextiles:			\$0.00
1400 Slope Protection:			\$0.00
1800 Soil Stabilization:	0.00 acres		\$0.00
1900 Cattleguards:			\$0.00
2100 RoadSide Brushing:			\$73.28
	Mechanical Brushing:	0.30 acres	
2300 Engineering:	0.00 sta.		\$0.00
2400 Minor Concrete:			\$0.00
2500 Gabions:			\$0.00
8000 Miscellaneous:			\$0.00
Mobilization:	Const. \$2,931.86	Surf. \$3,259.71	\$6,191.57
Quarry Development:			\$0.00
		Total:	3,825 mbf @ \$49.438/mbf = \$189,101.11

Notes:

Quantities shown are estimates only and not pay items.
Surfacing Quantities are loose cubic yards.

UNITED STATES
DEPARTMENT OF THE INTERIOR
BUREAU OF LAND MANAGEMENT

Contract Name: Conley Creek Fire Salvage
Sale Date: 12/16/2021
Tract No: 2022.0016

ROAD CONSTRUCTION SUMMARY

1/ Const/Impr/Renov/Decom/Temp 2/ yd-miles haul 3/ Lin ft CMP 4/ Lin ft Polypipe 5/ Lin ft Downspout 6/ slide removal cy

Road Number	Type 1/	Miles	Clear Grubb	Excav -ation	Drain -age	Reno- vation	Surf- acing	Geo- textile	Slope Protect	Soil Stabil	Cattle Guard	Rdside Brush	Engin- eering	Minor Concrete	Gab- ions	Miscel- laneous	Mobil- ization	Quarry Develop	Sub- Total
25-2-21.2	R	0.12	\$215			\$125	\$10,274					\$73					\$383		\$11,070
25-2-27.1	R	1.21	\$447			\$1,721	\$34,697										\$1,237		\$38,102
25-2-28.1	R	0.98	\$247	\$142	\$11,864	\$1,394	\$82,678										\$3,192		\$99,517
Spur 1	R	0.09				\$104	\$11,398										\$425		\$11,927
Spur 2	R	0.12	\$769		\$1,695	\$125	\$12,994										\$534		\$16,116
Spur 3	R	0.09	\$179			\$104	\$11,665										\$421		\$12,369

TIMBER SALE ROAD SPECIFICATIONS

TABLE OF CONTENTS

SECTION	DESCRIPTION
100	General
200	Clearing and Grubbing
300	Excavation and Embankment
400	Pipe Culverts
500	Renovation and Improvement of Existing Roads
600	Watering
1000	Aggregate Base Course - Crushed Rock
1200	Aggregate Surface Course - Crushed Rock
1700	Erosion Control
1800	Soil Stabilization
2100	Roadside Brushing

TIMBER SALE ROAD SPECIFICATIONS

GENERAL – 100

101 - Prewrite Conference(s):

A prework conference will be held prior to the start of new construction, improvement, renovation, quarry development, surfacing, and mulching operations. The Purchaser shall request the conference at least 48 hours prior to the time it is to be held. The conference will be attended by the Purchaser and/or his representatives, subcontractors and/or his or their representatives and the Authorized Officer and/or his representatives.

The purpose of the prework conference will be to review the required work, exhibits and specifications, and to establish a work schedule and a list of the Purchaser's representatives, and subcontractors.

102 - Definitions:

AASHTO - American Association of State Highway and Transportation Officials. Current editions of tests and specifications.

Abrasion Resistance - The ability of a fabric surface to resist wear by friction.

ACI - American Concrete Institute

Apparent Opening Size (AOS) - Number of the U.S. Bureau of Standard sieve (or its opening size in millimeters or inches) having openings closest in size to the diameter of uniform particles which will allow 5 percent by weight to pass through the geotextile material when shaken in a prescribed manner. This is also referred to as Equivalent Opening Size (EOS).

ASTM - American Society for Testing and Materials.

Base Course - Surfacing structure consisting of crushed gravel or stone, crushed sandstone, pitrun rock, bank or river-run gravels, etc., to provide support and, in the event no surface course is placed, the running surface for traffic load.

BLM - Bureau of Land Management

Borrow - Excavated material required for embankments and other portions of the work.

TIMBER SALE ROAD SPECIFICATIONS

Burst Strength - The resistance of a geotextile material to rupture from pressure applied at right angles to the plane of the geotextile material under specified conditions, usually expressed as the amount of pressure causing failure. Rupture or burst results from tensile failure of the geotextile material.

Culvert - A pipe, pipe-arch, arch, or box structure constructed of metal, concrete, plastic or wood which provides an opening under the roadway primarily for the conveyance of liquids, pedestrians or livestock.

Curve Widening - Widening required on inside of curves to accommodate long log and equipment hauling trucks.

Embankment - A structure of soil, aggregate, or rock material placed on a prepared ground surface and constructed to subgrade.

End Haul - Excavated material moved, other than by dozer, to an embankment or waste area to prevent sidecasting material outside of the road prism.

Excess Excavation - Material from the roadway in excess of that needed for construction of the designed roadway (waste).

Grab Tensile Strength - A modified tensile strength of a geotextile material. The strength of a specific width of geotextile material together with the additional strength contributed by adjacent areas. Typically, grab strength is determined on a 12-inch-wide strip of geotextile material, with the tensile load applied at the midpoint of the geotextile material width through 1-inch-wide jaw faces.

Grading - Leveling to grade, shaping and smoothing of a road subgrade; the shaping of roadside ditches as to grade and contour. In some instances includes smoothing of the cut bank.

Nonwoven Geotextile Material - A textile structure produced by bonding or interlocking of fibers, or both, accomplished by mechanical or chemical means.

Overhaul - Distance excavated material is transported in excess of the distance included in the cost for excavation.

Penetration Resistance - The geotextile material property determined by the force required to penetrate a geotextile material with a sharp pointed object. Initial penetration is by separating the fibers. Further penetration is essentially a tearing process.

TIMBER SALE ROAD SPECIFICATIONS

Percent Open Area - The net area of a geotextile material that is not occupied by geotextile material filaments, normally determinable only for woven and nonwoven geotextile material having distinct, visible, and measurable openings that continue directly through the geotextile material.

Permeability - The geotextile material property which permits water to be transmitted in the longitudinal or transverse planes of the geotextile material.

Pioneer Road - Temporary construction access built along the route of the project.

Piping - The process by which soil particles are washed in or through pore spaces in drains and filters or poorly compacted fill/backfill material.

Plans - The approved drawings, or exact reproductions thereof which show the locations, character, dimensions, and details of the work to be done.

Pore Size - The size of an opening between geotextile material filaments; apparent opening size (AOS) is used to quantify this geotextile material property.

Puncture Resistance - The geotextile material property determined by the force required to penetrate a geotextile material with a blunt object. Failure results in a tearing of the geotextile material.

Purchaser - The individual, partnership, joint venture, or corporation contracting with the Government under the terms of a Timber Sale Contract and acting independently or through their, or its agents, employees, or contractors.

Reasonably Close Conformity - Compliance with reasonable and customary manufacturing and construction tolerances where working tolerances are not specified.

Reinforcement - Strengthening of concrete with iron bars or mesh: geotextile with geotextile material inclusion: subgrade with aggregate: etc.

Roadbed - The graded portion of the road within top and side slopes, prepared as a foundation for the pavement structure and shoulders.

Road Centerline - The longitudinal center of a roadbed.

Road Improvement - Work done to an existing road which improves it over its original design standard.

TIMBER SALE ROAD SPECIFICATIONS

Road Renovation - Work done to an existing road which restores it to its original design.

Roadway - The portion of a road within limits of construction. Usually from the toe of the fill slope to a point where the cut slope intersects natural ground line. Synonym - road prism.

Scale - In quarrying, consists of the removal of loose or overhanging rock adhering to the solid face after a shot or a round of shots has been fired.

Scarification - The process of loosening or breaking up of the surface layer of soil or road, usually to a specified depth.

Separation - Function of geotextile material as a partition between adjacent materials to prevent mixing of those materials.

Shoulder - The portion of the roadbed contiguous with the traveled way designed for accommodation of stopped vehicles, safety, and lateral support of base and surface courses.

Slash – All material (brush, limbs, tops, unmerchantable stems, and chunks) severed or knocked over as a result of clearing or brushing operations.

Slash Mulch – A mulch consisting of clearing, grubbing, or logging debris, commonly used for road decommissioning. If slash mulch is not available, other mulches may be substituted as described in sections 1800 and 3500 of this contract.

Spalls - Flakes or chips of stone.

Specifications - A general term applied to all directions, provisions, and requirements pertaining to performance of the work.

Specific Gravity - The ratio of the density of a material to the density of water obtained by weighing known volumes of both items in air. A specific gravity less than one implies that the material will float.

Structures - Bridges, culverts, catch basins, retaining walls, underdrains, flumes, splash pads, downspouts, and other project features which may be involved in the work and not otherwise classified in these specifications.

Subbase - Reinforcement of the subgrade with large particles of pitrun rock or crushed stone. Usually confined to roads having wet subgrades or subgrades with weak support characteristics.

TIMBER SALE ROAD SPECIFICATIONS

Surface Course - Top layer of a road structure consisting of finely crushed gravels or asphalt designed to provide a smooth running surface for traffic load.

Subgrade - The top surface of a roadbed upon which the traveled way and shoulders are constructed.

Tensile Strength - The strength shown by a geotextile material subjected to tension as distinct from torsion, compression, or shear.

Tensile Stress - Strain Modulus - A measure of the resistance to elongation under stress. The ratio of the change in tensile stress to the corresponding change in strain.

Tensile Test - A test which subjects geotextile material to tensile forces and measures resultant stresses and strains.

Timber - Standing trees, downed trees, or logs which can be measured in board feet.

Traveled Way - The portion of the roadbed used for the movement of vehicles, exclusive of shoulders.

Typical Cross Sections - Cross-sectional plane of a typical roadway; showing natural ground line and designed roadway in relation to cut and fill, through cut, and through fill.

Turnout - Extra widening of the roadbed at appropriate intervals on single-lane roads for passing purposes.

Ultraviolet (UV) Radiation Stability - The ability of geotextile material to resist deterioration from exposure to sunlight.

Unaged Cloth - Cloth in condition received from the manufacturer or distributor.

Woven Geotextile Material - A textile structure comprising two or more sets of filaments of yarns interlaced in such a way that the elements pass each other at essentially right angles with one set of elements parallel to the geotextile material axis.

102a - Tests Used in These Specifications:

AASHTO T 11
Quantity of rock finer than No. 200 sieve.

TIMBER SALE ROAD SPECIFICATIONS

AASHTO T 27

Sieve analysis of fine and coarse aggregate using sieves with square openings; gradation.

AASHTO T 89

Liquid limit of material passing the No. 40 sieve. Water content at which the soil passes from a plastic to a liquid state.

AASHTO T 90

Plastic limits and plasticity index of soil.

- a. Plastic limit - lowest water content at which the soil remains plastic.
- b. Plasticity index - range of water content, within which the material is in a plastic state.
Numerical difference between the liquid and plastic limits of the soil.

AASHTO T 96

Resistance to abrasion of small size coarse aggregate by use of the Los Angeles machine.

AASHTO T 99

Relationship between soil moisture and density of soil.

Method A - 4" mold, soil passing a No. 4 sieve

25 blows/layer & 3 layers.

Method C - 4" mold, soil passing a 3/4 inch sieve

25 blows/layer & 3 layers.

Method D - 6" mold, soil passing a 3/4 inch sieve. 56 blows/layer & 3 layers.

AASHTO T 119

Slump of hydraulic cement concrete.

AASHTO T 152

Air content of freshly mixed concrete.

AASHTO T 166

Specific Gravity of compacted Bituminous Mixtures.

AASHTO T 176

Shows relative portions of fine dust or claylike materials in soil or graded aggregate.

AASHTO T 180

(OSHD 106-71) moisture density relationship of soil same as AASHTO T 99 proctor but uses a 10-lb rammer & 18-in drop height.

TIMBER SALE ROAD SPECIFICATIONS

AASHTO T 191

Sand Cone. Density of soil in place: For subgrade use 6-inch or 12-inch cone. For rock surfacing for 1-1/2-inch minus to 3-inch minus use 12-inch cone.

AASHTO T 205

Rubber balloon. Density of soil in place. Use for compacted or firmly bonded soil.

AASHTO T 209

Maximum Specific Gravity of Bituminous Paving Mixtures.

AASHTO T 210

Durability of aggregates based on resistance to produce fines.

AASHTO T 224

Correction for coarse particles in the soil.

AASHTO T 238

Density of Soil and Soil-Aggregate in place by nuclear methods.

AASHTO T 248

Reducing field samples of aggregate to testing size by mechanical splitter, quartering, or miniature stockpile sampling.

ASTM D 4564

Determination of relative density of cohesionless soils.

DMSO (dimethyl sulfide)

Determines volume of expanding clays in aggregates. Usually associated with marine basalts.

- 103 - Compaction equipment shall meet the following requirements:
- 103a - Padded Drum (Tamping) Rollers. The unit shall consist of a drum with pads, be either self propelled or towed by a tractor, and capable of operating at a speed of 6 mph. The drum shall be no less than 48 inches in diameter over the pads and not less than 60 inches in width. The pads shall have a minimum height of 3 inches, and a face area of not less than 14 square inches. The weight at drum shall be no less than 8000 lb.

TIMBER SALE ROAD SPECIFICATIONS

- 103b - Sheepfoot (Tamping) rollers. A tamping roller unit shall consist of two watertight metal drums mounted in frames in such manner as to be fully oscillating, together with a tractor having sufficient weight and power under actual working conditions to pull the roller drums at a minimum speed of 2.5 miles per hour. The drums shall be no less than 60 inches in diameter and no less than 54 inches in length, measured at the drum's surface, and shall be studded with tamping feet projecting not less than 7 inches from the face of the drums.

The distance between circumferential rows of tamper feet shall be such that the diagonal distance from any foot to the nearest foot in each adjacent row shall be not more than 12 inches. The cross-sectional area of the face of each tamper foot, measured perpendicular to the axis of the stud, shall be not less than 5-1/2 square inches nor more than 8 square inches.

The weight of the tamping-roller unit shall be such as to exert a minimum pressure of 250 pounds per square inch on the ground area in contact with the tamping feet, and the roller shall be so designed that the weight may be increased to exert a pressure up to 500 pounds per square inch on the ground area in contact with the tamping feet. The ground pressure shall be determined by dividing the total weight of the roller unit, not including the weight of the tractor, by the total cross-sectional area of the tamping feet in one row of tamping feet parallel to the axis of the roller.

- 103c - Smooth-wheel power rollers. Smooth-wheel power rollers shall either be of the 3-wheel type, weighing not less than 10 tons, or of the tandem type, 2-wheel or 3-wheel, weighing not less than 8 tons. Smooth-wheel roller shall provide compression of 325 pounds per linear inch of width of rear wheels or drum.

- 103d - Pneumatic-tired rollers. Pneumatic-tired rollers shall be of the double-axle type equipped with pneumatic tires each of equal size and type. The spacing between the sidewalls of adjacent tires shall not exceed 5 inches and the rear tires shall be staggered in relation to the front tires. The rolling width of the unit shall be not less than 60 inches, exclusive of the power unit. The roller shall be so constructed that the contact pressure is uniformly distributed on all of the tires, and the tires shall be inflated to maintain the air pressure in the several tires within a total tolerance of 5 pounds per square inch. The roller shall be so constructed that the total weight shall be between 1,000 and 2,000 pounds per tire. The actual operating weight of the rollers shall be as ordered by the Authorized Officer.

TIMBER SALE ROAD SPECIFICATIONS

Each pneumatic-tired roller shall be drawn by equipment having sufficient power and weight under normal working condition to pull the roller at a minimum speed of 5 miles per hour, or it may be self-propelled to obtain a minimum speed of 5 miles per hour.

- 103e - Grid roller. A grid roller shall consist of two or more cylindrical drums independently mounted on a common shaft in a rigid frame. Each drum shall have a minimum outside diameter of 5 feet and a minimum width of 2 feet 6 inches. The overall width of the roller exclusive of frame shall be not less than 5 feet 6 inches of which not more than 6 inches shall be used for center spacing between two roller drums. The face of the drums shall have the appearance of woven open-mesh made by interlacing bars of not less than 1-1/4 inches nor more than 1-3/4 inches diameter space spaced on 4-1/2 inches to 5-1/2 inches center. Net opening between the bars shall be not less than 3 inches nor more than 4 inches. The roller shall be so constructed that counterweights can be used to adjust the gross weight of the roller to not less than 27,000 pounds. The grid roller shall be drawn by a power unit capable of propelling the fully loaded roller through 6 inches of loose embankment material at a speed of at least 4 miles per hour.
- 103f - Vibratory roller. The drum diameter shall be not less than 48 inches, the drum width not less than 58 inches, and have a turning radius of 15 feet or less. Vibration frequency shall be regulated in steps to 1400, 1500, and 1600 vibrations per minute (VPM), corresponding to engine speeds of 1575, 1690, and 1800 RPM. The centrifugal force developed shall be 7 tons at 1600 RPM. It shall be activated by a power unit of not less than 25 horsepower. The vibratory roller shall be self-propelled or drawn by a vehicle of sufficient horsepower to enable the unit to travel through a loose layer of material at a speed ranging from 0.9 mile to 1.8 miles per hour, as directed by the Authorized Officer.
- The towing vehicle and roller or self-propelled unit meeting the above requirements shall be considered a vibratory roller unit.
- 103g - Vibratory compactor. Vibratory compactors shall consist of multiple or gang-type compacting units or pads with a minimum variable width of 2 feet. It shall be self-contained and capable of compacting material as required.
- 103h - Drum drive self-propelled vibratory grid roller. The unit shall consist of one cylindrical drum with a drum diameter of not less than 56 inches, nor more than 66 inches and the drum width shall be 84 inches. Vibratory frequency shall be regulated in steps from 1200 to 1800 vibrations per minute (VPM), and the centrifugal force developed shall be at least 40,000 pounds at 1800 RPM. The

TIMBER SALE ROAD SPECIFICATIONS

vibratory grid roller shall be self-propelled and have a power unit of not less than 112 horsepower. The "grid" design shall be a herringbone or z-bar pattern around the circumference of the drum. The grid bars shall be 1 inch in height and spaced not more than 8-1/2 inches apart.

- 103i - Other. Compaction equipment approved by the Authorized Officer.

CLEARING AND GRUBBING - 200

- 201 - This work shall consist of clearing, grubbing, removing and disposing of vegetation, debris, surface objects, and protruding obstructions within the clearing limits in accordance with these specifications and conforming to the lines, grades, dimensions and typical cross sections shown on the plans.
- 201a - This work shall consist of clearing, grubbing, removing and disposing of vegetation, debris, surface objects, and protruding obstructions from borrow pits, quarries, channel changes, stockpile sites, etc., in accordance with these specifications.
- 202 - Where clearing limits have not been staked, established by these specifications or shown on the plans, the limits shall extend 10 feet back of the top of the cut slope and 5 feet out from the toe of the fill slope.
- 202a - Where clearing limits for structures have not been staked or shown on the plans, the limits shall extend 10 feet out from the outside edge of the structure.
- 202b - Where clearing limits for borrow pits, or quarries, stockpile sites, channel changes, and ditches have not been staked or shown on the plans, the limits shall extend 10 feet back of the top of the cut slope and 5 feet outside of the outside slope lines.
- 203 - Clearing shall consist of the removal and disposal of trees, logs, rotten material, brush, and other vegetative materials and surface objects in accordance with these specifications and within the limits established for clearing as specified under Subsections 202, 202a, 202b, and as shown on the plans.
- 203a - Brush under 2 feet in height need not be cut within the limits established for clearing.

TIMBER SALE ROAD SPECIFICATIONS

- 203c - Disposal of logs from private timber cleared within the limits established as staked on the ground shall consist of decking at a location designated by the Authorized Officer.
- 204 - Grubbing shall consist of the removal and disposal of stumps, roots, and other wood material embedded in the ground and protruding obstacles remaining as a result of the clearing operation in accordance with Subsections 204a, 204b, 204c, and 204d.
 - 204a - Stumps, including those overhanging cut banks, shall be removed within the required excavation limits.
 - 204b - Stumps and other protruding objects shall be completely removed within the limits of required embankments having heights of less than 4 feet. When authorized, stumps and other nonperishable objects may be left provided they do not extend more than 6 inches above the existing ground line.
 - 204c - On excavated areas, roots and embedded wood shall be removed to a depth not less than 6 inches below the subgrade.
 - 204d - On areas to be occupied by embankments having heights greater than 4 feet, no stump or portion thereof shall remain within 3 feet of embankment subgrades or slope surfaces after grubbing is completed.
- 205 - Clearing and grubbing debris shall not be placed or permitted to remain in or under road embankment sections.
- 210 - Disposal of clearing and grubbing debris shall be by piling or scattering over government owned lands outside of established clearing limits in a manner acceptable to the Authorized Officer. The areas for such scattering or piling shall have the prior approval of the Authorized Officer. Piled slash may be re-used as mulch during road decommissioning.
 - 210a - Disposal of clearing and grubbing on non-government property by scattering this material outside of clearing limits will be permitted provided the Purchaser obtains a written permit from the property owner on whose property the disposal is to be made. The Purchaser shall furnish the Authorized Officer a certified copy of the permit and a written release from the property owner absolving the Government from responsibilities in connection with the disposal of debris on said property.

TIMBER SALE ROAD SPECIFICATIONS

- 212 - No grading will be permitted prior to completion and approval by the Authorized Officer of the required clearing and grubbing work, except that stump grubbing may proceed with the excavation of the road prism.
- 213 - No clearing or grubbing debris shall be left lodged against standing trees.

EXCAVATION AND EMBANKMENT - 300

- 301 - This work shall consist of excavating, overhaul, placement of embankments, backfilling, borrowing, leveling, ditching, grading, insloping, outsloping, crowning and scarification of the subgrade, compaction, disposal of excess and unsuitable materials, and other earth-moving work in accordance with these specifications and conforming to the lines, grades, dimensions, and typical cross sections shown on the plans.
- 302 - Excavation shall also consist of the excavation of road and landing cut sections, borrow sites, backfilling, leveling, ditching, grading, compaction, and other earth moving work necessary for the construction of the roadway in accordance with these specifications and conforming to the lines, grades, dimensions, and typical cross sections shown on the plans and as marked on the ground with stakes or metal tags.
- 303 - Suitable material removed from the excavation shall be used in the formation of embankment subgrade, shoulders, slopes, bedding, backfill for structures, and for other purposes as shown on the plans.
- 305 - Embankment construction shall consist of the placement of excavated and borrowed materials, backfilling, leveling, grading, compaction, and other earth-moving work necessary for the construction of the roadway and landings in accordance with these specifications and conforming to the lines, grades, dimensions, and typical cross sections shown on the plans.
- 305a - Material used in the construction of embankment sections shall be free of stumps, cull logs, brush, muck, sod, roots, frozen material, and other deleterious materials and shall be placed and compacted as specified.

TIMBER SALE ROAD SPECIFICATIONS

- 305b - Embankment materials shall be placed in successive parallel layers on areas cleared of stumps, cull logs, brush, sod, and other vegetative and deleterious materials, except as provided under Subsection 204. Roadway embankments of earth material shall be placed in horizontal layers not exceeding 12 inches in depth.

- 305c - Embankments formed of material containing less than 25 percent rock not larger than 8 inches in the greatest dimension shall be placed in 12-inch layers. Material containing more than 25 percent rock not larger than 12 inches in the greatest dimension shall be placed in successive layers not exceeding 2 feet in thickness. Individual rocks and boulders greater than 12 inches in diameter may be used to construct 2 foot embankment layers, provided they are carefully distributed, with interstices filled with fine material to form a dense and compact mass.

- 305d - Where embankments are constructed predominantly of blasted rock material, depth of layers shall not exceed 4 feet. Rock fragments having dimensions greater than 4 feet will be permitted provided that they have no dimensions greater than 6 feet and that clearance between adjacent fragments is adequate for the placing and compacting of material in horizontal layers as specified, and that no part of the larger fragments comes within 4 feet of subgrade.

- 306 - Layers of embankment, selected borrow, final subgrade, and selected roadway excavation material as specified under Subsections 305a, and 305b shall be moistened or dried to a uniform optimum moisture content suitable for maximum density and compacted to full width with compacting equipment conforming to requirements of Subsections 103f and 103i.

- ...
- 306a - Optimum moisture content shall be determined by hand clump test i.e., where a soil sample forms a firm ball by hand that does not crumble, free moisture is not visible on the surface, and material does not squeeze between fingers.

- 306b - Minimum compaction for each layer of embankment, selected borrow, and selected roadway excavation material placed at optimum moisture shall be a minimum of 8 complete passes or until visual displacement ceases.

TIMBER SALE ROAD SPECIFICATIONS

- 308 - In the case of rock fills, placement of material in layers is not required and such material may be placed by end-dumping or other methods approved by the Authorized Officer provided that the rock be reasonably prevented from escaping beyond the embankment toe.

- 312 - When material, except solid rock, encountered in cuts at subgrade, is suitable for use in forming the finished roadbed, the top 6-inch layer of the subgrade shall be thoroughly scarified for the full width of the roadbed. Roots, sod, and other deleterious material or stones that will not pass a 6-inch square opening shall be removed. The scarified material shall be processed to the optimum moisture content suitable for maximum density and compacted in accordance with Subsection 306.

- 313 - In cut areas where solid rock is encountered at, or near subgrade, the rock shall be excavated to a minimum depth of 6 inches below subgrade elevation and the excavated area backfilled with suitable material. The backfill material shall be processed to the optimum moisture content suitable for maximum density and compacted to full width in accordance with the requirements of Subsection 306.

- 320 - Ditches shall conform to the slope, grade, dimensions, and shape of the required cross section shown on the plans. Roots, stumps, rocks, and other projections shall be removed to form smooth, even slopes.

- 321 - Excess excavated, unsuitable, or slide materials shall not be disposed of on areas where the material will encroach on a stream course or other body of water. Such materials shall be disposed of in accordance with Subsection and 321c. Materials not disposed of in this manner shall be retrieved and disposed of at the Purchaser's expense and at the direction of the Authorized Officer.

- 321b - Excess construction material as specified under Subsection 321 shall be loaded, hauled, and disposed of at a designated disposal site or used as embankment for designated roadbeds as shown on the plans.

- 321c - End-dumping will be permitted for the placement of excess materials under Subsection 321 in designated disposal areas or within areas approved by the Authorized Officer. Watering, rolling, and placement in layers are not required.

TIMBER SALE ROAD SPECIFICATIONS

Materials placed shall be sloped, shaped, and otherwise brought to a visible condition acceptable to the Authorized Officer.

- 324 - Excavated material shall not be allowed to cover boles of standing trees to a depth in excess of 2 feet on the uphill side.
- 327 - The finished grading shall be approved by the Authorized Officer in segments. The Purchaser shall give the Authorized Officer 3 days notice prior to start of surfacing operations.

PIPE CULVERTS - 400

- 401 - This work shall consist of furnishing and installing pipe culverts and other erosion control devices in accordance with these specifications and conforming to the lines, grades, dimensions, and typical cross sections shown on the plans. Individual lengths and locations are approximate; final lengths and locations will be determined by the Authorized Officer upon completion of the roadbed and upon installation of the appurtenance structures. Additional pipe and erosion control devices may be required at the option of the Authorized Officer, in which case a reduction in the total purchase price shall be made to offset the cost of furnishing and installing such items. Costs will be based upon the unit prices set forth in the current BLM Timber Appraisal Production Cost Schedule.
- 403 - Grade culverts shall have a gradient of 2 percent to 4 percent greater than the adjacent road grade. Grade culverts shall be skewed down grade 30 degrees as measured from the perpendicular to the centerline unless otherwise specified on the plans.
- 405b - Corrugated-aluminum-alloy pipe culverts and pipe-arch culverts shall conform to the requirements of AASHTO M 196.
- 405e - Corrugated-polyethylene pipe for culverts 12-inch through 36-inch diameter shall meet the requirements of AASHTO M 294.
- 406 - Coupling bands shall conform to the requirements of AASHTO M 36 and AASHTO M 218 or AASHTO M 274 with the exception of band widths and the

TIMBER SALE ROAD SPECIFICATIONS

- "Hugger"-type band which shall conform to the details, dimensions, and typical diagram shown on the plans.
- 406a - "Hugger"-type coupling bands shall only be used with annular corrugated pipe and pipe-arch culverts, or helically corrugated pipe and pipe-arch culverts having annular reformed ends. Annular reformed ends shall consist of two annular corrugations.
- 407 - Special sections, such as elbows, branch connections, and flared-end sections, shall be of the same gauge as the pipe to which they are joined, and shall conform to the requirements of AASHTO M 36 and AASHTO M 218 or AASHTO M 274.
- 408 - Pipe culverts and pipe-arch culverts shall be placed on the bed starting at the downstream end with the inside circumferential laps pointing downstream and with the longitudinal laps at the side or quarter points. Coupling bands of the type required under these specifications shall be installed so as to provide the circumferential and longitudinal strength necessary to preserve the pipe alignment, prevent separation of the pipe sections, and minimize infiltration of fill material.
- 410 - Pipe shall be unloaded and handled with reasonable care. If the Authorized Officer determines any structure is damaged to the extent that it is unsuitable for use in the road construction, it shall be replaced at the Purchaser's expense.
- 411 - Trenches necessary for the installation of pipe culverts shall conform to the lines, grades, dimensions, and typical diagram shown on the Culvert Installation Detail Sheet.
- 412 - Where ledge rock or boulders are encountered, they shall be excavated a minimum of 10 inches below the invert grade for a width of at least 2 feet on each side of the pipe and shall be backfilled with compacted select fill material.
- 412a - Where soft or spongy soils are encountered, they shall be excavated a minimum of 2 feet below the invert grade for a width of at least one pipe diameter on each side of the pipe and shall be backfilled with compacted select fill material.

TIMBER SALE ROAD SPECIFICATIONS

- 413 - Pipe culverts shall be bedded on select fill material, having a depth of not less than 6 inches as shown on plans. Foundation material shall be of uniform density throughout the length of the structure and shall be shaped to fit the pipe.

- 416 - Select fill material for pipe culverts shall be fine readily compactable soil, or crushed rock material in accordance with Section 1204 gradation C, as shown on the plans.

- 417 - For pipe culverts:
Side-fill material conforming to the requirements of Subsection 416 shall be placed and compacted under the haunches of the pipe, and shall be brought up evenly and simultaneously on both sides of the pipe to 1 foot above the pipe, in layers not exceeding 6 inches in depth and 1 pipe diameter/span, or a minimum of 2 feet in width each side of, and adjacent to, the full length of the pipe barrel. Each layer shall be moistened or dried to a uniform moisture content suitable for maximum compaction and immediately compacted by approved hand or pneumatic tampers as specified in Subsection 306.

- 418 - Side fills beyond the compaction limits specified under Subsection 417 shall be compacted as specified under Section 300.

- 419 - The pipe culvert after being bedded and backfilled as required by these specifications shall be protected by a 1-foot cover of fill before heavy equipment is permitted to cross the drainage structures. Removal of the protection fill shall be as directed by the Authorized Officer.

- 423 - Construction of catch basins conforming to lines, grades, dimensions and typical diagrams shown on the plans, shall be required for culverts.

- 424 - Construction of splash pads conforming to lines, grades, dimensions and typical diagram shown on the plans, shall be required for grade culverts.

- 427 - Record culvert sizes, lengths and location actually installed on a copy of the culvert list. This culvert list shall be furnished to the Authorized Officer.

- 428 - Remove and dispose of old culverts in a legal manner, and for any fees required. The Purchaser shall remove the old culverts from the work site prior to road acceptance.

TIMBER SALE ROAD SPECIFICATIONS

- 429 - Keep the excavation site dewatered so that the installation of culverts is completed under dry conditions. Dispose of excess water in a manner that will avoid damage to adjacent property. Diversion streams shall not be returned to the natural channel until all in-stream work has been completed.

RENOVATION AND IMPROVEMENT OF EXISTING ROADS - 500

- 501 - This work shall consist of reconditioning and preparing the roadbed and shoulders, installing culverts and splash pads, minor excavation and/or embankment, cleaning and shaping drainage ditches, brushing vegetation from cut and embankment slopes, daylighting, cleaning and repairing drainage structures of existing roads in accordance with these specifications, as shown on the plans, and as marked on the ground with stakes or metal tags.
- 501a - This work shall include the removal and disposal of slides in accordance with these specifications.
- 502 - The existing road surface shall be bladed and shaped to the lines, grades, dimensions, and typical cross sections shown on the plans and as marked on the ground with stakes or metal tags.
- 502a - Rocks larger than 4 inches in maximum dimension shall be removed from the scarified layers of the roadbed. Material so removed will not be permitted to remain on road shoulders or in ditches.
- 502b - Drainage ditches shall be bladed and shaped in accordance with the lines, grades, dimensions, and typical cross sections shown on the plans.
- 504 - Existing road surface shall be uniformly moistened or dried to the optimum moisture content suitable for maximum density and compacted to full width with equipment conforming to requirements of Subsection 103f and 103i.
- 504a - Minimum compaction required shall be a minimum of 8 passes over each full-width layer, or until visual displacement ceases.
- 506 - The inlet end of existing drainage structures shall be cleared of vegetative debris and boulders that are of sufficient size to obstruct normal stream flow. Pipe

TIMBER SALE ROAD SPECIFICATIONS

inverts shall be cleared of sediment and other debris lodged in the barrel of the pipe. The outflow area of pipe structures shall be cleared of rock and vegetative obstructions which will impede the structure's designed outflow configuration. Catch basins shall conform to the lines, grade, dimensions, and typical diagram shown on the plans.

- 509 - The finished grading shall be approved by the Authorized Officer 1 day prior to surfacing operations. The Purchaser shall give the Authorized Officer 3 days notice prior to final inspection of the grading operations.
 - 510 - Unless otherwise shown on the plans, daylighting shall include removing shrubs and trees within 33 feet from the centerline of existing roads, as shown on the plans and marked on the ground, in accordance with Section 200 (Clearing and Grubbing).
- Note: The distance from the road centerline to the clearing limits posted on the ground may vary. Daylighting operations are only required within 33 feet of road centerline or up to the posted clearing limits, whichever is closest to the centerline of the road.
- 510b - Unless otherwise shown on the plans, stumps located within 5 feet of the edge of road shall be cut to a maximum height of 4 inches above the ground surface or above obstructions such as rocks.
 - 510c - Unless otherwise shown on the plans, trees reserved from cutting are marked with orange paint, and shall be limbed to a minimum height of 14 feet above the running surface of the roadway.
 - 510d - All slash generated during daylighting operations shall be piled and covered with plastic sheeting in accordance with Section 42(F)(1) of the contract.

WATERING - 600

- 601 - This work shall consist of furnishing and applying water required for the compaction of embankments, roadbeds, backfills, base courses, surface courses, finishing and reconditioning of existing roadbeds, laying dust, or for other uses in accordance with these specifications.
- 602 - Water, when needed for compaction or laying dust, shall be applied at the locations, in the amounts, and during the hours as directed by the Authorized

TIMBER SALE ROAD SPECIFICATIONS

Officer. Amounts of water to be provided will be the minimum needed to properly execute the compaction requirements in conformance with these specifications, and for laying dust during work periods.

- 603 - Water trucks used in this work shall be equipped with a distributing device of ample capacity and of such design as to ensure uniform application of water on the road bed.
- 605 - The Purchaser shall secure the necessary water permits and pay all required water fees for use of water sources selected by the Purchaser and approved by the Authorized Officer.

AGGREGATE BASE COURSE - 1000 **CRUSHED ROCK MATERIAL**

- 1001 - This work shall consist of furnishing, hauling, and placing one or more lifts of crushed rock material on roadbeds and landings approved for placing crushed rock material, in accordance with these specifications and conforming to the dimensions and typical cross sections shown on the plans. Material not conforming to these specifications will be rejected and shall be removed from the road at the purchaser's expense.
- 1002a - Crushed rock materials may be obtained from commercial sources selected by the Purchaser at his option and expense providing that the rock materials selected comply with the specifications in this section.
- 1002b - In accordance with Subsections 1005, 1006, and 1006a, the following test reports for crushed rock material shall be submitted to, and approved by, the Authorized Officer, prior to delivery and placement of aggregate: AASHTO T96, AASHTO T210, and DMSO. Tests must have been conducted within the last 365 days and be for the same quarry shot that the crushed rock is coming from. New tests must be performed if there is a new shot, or other change in the material being supplied to the crusher.

TIMBER SALE ROAD SPECIFICATIONS

- 1002c - In accordance with Subsection 1004, the following test reports for crushed rock material shall be submitted to and approved by the Authorized Officer, prior to delivery and placement of aggregate: AASHTO T11 and AASHTO T27.

- 1003 - Crushed rock material produced from gravel shall have 2 manufactured fractured faces on 65 percent, by weight, of the material retained on the No. 4 sieve.

- 1004 - Crushed rock materials shall consist of hard durable rock fragments conforming to the following gradation requirements (as determined by AASHTO T11 & T27):

TABLE 1004
AGGREGATE BASE COURSE
CRUSHED ROCK MATERIAL
 Percentage by Weight Passing Square Mesh Sieves
 (AASHTO T 11 & T 27)

GRADATION

Sieve Designation	A	B	C	D	F	G	H	I
6 -inch	-	-	-	-	-	-	-	100
3-inch	100	-	100	-	100	-	-	45-65
2-inch	90-95	100	-	-	65-95	100	100	-
1 1/2-inch	-	90-95	-	-	-	-	-	-
1-inch	45-75	50-90	-	100	-	50-85	60-90	-
3/4-inch	-	-	-	-	28-70	-	-	-
1/2-inch	-	-	-	0-20	-	27-60	44-70	-
3/8-inch	-	-	-	-	-	-	-	-
No. 4	15-45	15-50	-	0-5	10-35	15-40	28-50	0-10
No. 8	-	-	-	-	-	-	20-41	-
No. 10	-	-	-	-	-	-	-	-
No. 30	-	-	-	-	5-22	8-26	9-26	-
No. 40	5-25	5-25	-	-	-	-	-	-
No. 200	2-15	2-15	-	-	3-10	3-12	3-12	-

TIMBER SALE ROAD SPECIFICATIONS

- 1004j - Gabion rock shall be sound, durable and from a source approved by the Authorized Officer. Rock shall not be less than 4 inches minimum dimension, nor greater than 8 inches maximum dimension. The rock shall be reasonably well graded between the limiting sizes.

- 1005 - Crushed rock material retained on the No. 4 sieve shall have a percentage of loss of not more than 35 at 500 revolutions, as determined by AASHTO T 96.

- 1006 - Crushed rock material shall show durability value of not less than 35, as determined by AASHTO T 210.

- 1006a - The crushed rock material shall show a loss of not more than 20 percent by weight, when submerged in DMSO, dimethyl sulfoxide, for five days, according to Federal Highway Administration Region 10 Accelerated Weathering Test Procedure.

- 1008a - Each layer of crushed rock material shall be thoroughly mixed on the roadbed by alternately blading, to full depth, until a uniform mixture has been obtained. The mixture shall then be spread to full width. When completed, the spreading shall produce a surface which is smooth, presents uniform shoulder lines, and conforms to the specified cross section.

- 1009 - The roadbed, as shaped and compacted under Sections 300 and 500 of these specifications, shall be approved by the Authorized Officer prior to placement of crushed rock materials. Notification for final inspection prior to rocking shall be 72 hours prior to that inspection.

- 1010 - Crushed rock materials shall be placed and processed on the approved roadbed in accordance with these specifications and conforming to the lines, grades, dimensions, and typical cross sections shown on the plans and compacted in layers not to exceed 3 inches in depth. When more than one layer is required, each shall be shaped, processed, compacted, and approved in writing by the Authorized officer before the succeeding layer is placed. Irregularities or depressions that develop during compaction of the top layer shall be corrected by loosening the material at these places and adding or removing crushed rock material until the surface is smooth and uniform.

TIMBER SALE ROAD SPECIFICATIONS

- 1010a - Crushed rock material used to repair or reinforce a soft, muddy, frozen, yielding, or rutted roadbed shall not be construed as surfacing under this specification unless approved as such by the Authorized Officer prior to placement.
- 1012 - Each layer of crushed rock material shall be placed, processed, shaped, moistened or dried to a uniform moisture content suitable for maximum compaction, and compacted to full width by compaction equipment conforming to the requirements of Subsection 103f and 103i. Minimum compaction shall be a minimum of 8 passes over each full-width layer, or until visual displacement ceases.

AGGREGATE SURFACE COURSE - 1200 **CRUSHED ROCK MATERIAL**

- 1201 - This work shall consist of furnishing, hauling, and placing one or more layers of crushed rock material on roadbeds and base courses approved for placing crushed rock material in accordance with these specifications and conforming to the dimensions and typical cross sections shown on the plans. Material not conforming to these specifications will be rejected, and shall be removed from the road at the purchaser's expense.
- 1202a - Crushed rock materials used in this work may be obtained from commercial sources selected by the Purchaser at his option and expense, providing the rock materials furnished comply with these specifications.
- 1202b - In accordance with Subsections 1205, 1206, and 1206a, the following test reports for crushed rock material shall be submitted to and approved by the Authorized Officer, prior to delivery and placement of aggregate: AASHTO T96, AASHTO T210, and DMSO. Tests must have been conducted within the last 365 days and be for the same quarry shot that the crushed rock is coming from. New tests must be performed if there is a new shot, or other change in the material being supplied to the crusher.

TIMBER SALE ROAD SPECIFICATIONS

- 1202c - In accordance with Subsection 1204, the following test reports for crushed rock material shall be submitted to and approved by the Authorized Officer, prior to delivery and placement of aggregate: AASHTO T11 and AASHTO T27.

- 1203 - When crushed rock material is produced from gravel, not less than 65 percent by weight of the particles retained on the No. 4 sieve will have 2 manufactured fractured faces.

- 1204 - Crushed rock material shall consist of hard durable rock fragments conforming to the following gradation requirements (as determined by AASHTO T11 & T27):

TABLE 1204
AGGREGATE SURFACE COURSE
CRUSHED ROCK MATERIAL
 Percentage by weight passing square mesh sieves
 AASHTO T 11 & T 27

GRADATION

Sieve Designation	C	C-1	D	D-1	E	E-1
1-1/2-inch	100	100	-	-	-	-
1-inch	-	-	100	100	-	-
3/4-inch	50-90	60-90	-	70-98	100	100
1/2-inch	-	-	-	-	-	70-98
No. 4	25-50	30-55	30-60	36-60	40-75	44-70
No. 8	-	22-43	-	25-47	-	30-54
No. 30	-	11-27	-	12-31	-	15-34
No. 40	5-25	-	5-30	-	5-35	-
No. 200	2-15	3-15	3-15	3-15	2-15	3-15

- 1205 - Crushed rock material retained on the No. 4 sieve shall have a percentage of loss of not more than 35 at 500 revolutions, as determined by AASHTO T 96.

TIMBER SALE ROAD SPECIFICATIONS

- 1206 - Crushed rock material shall show a durability value of not less than 35 as determined by AASHTO T210.

- 1206a - The crushed rock material shall show a loss of not more than 20 percent by weight, when submerged in DMSO, dimethyl sulfoxide, for five days, according to Federal Highway Administration Region 10 Accelerated Weathering Test Procedure.

- 1208a - Each layer of crushed rock material shall be thoroughly mixed on the roadbed by alternately blading, to full depth, until a uniform mixture has been obtained. The mixture shall then be spread to full width. When completed, the spreading shall produce a surface which is smooth, presents uniform shoulder lines, and conforms to the specified cross section.

- 1209 - Shaping and compacting of roadbed base course shall be completed and approved by the Authorized Officer, prior to placing crushed rock material, in accordance to the requirements of Subsections 300 and 500. Notification for final inspection prior to rocking shall be 72 hours prior to the inspection.

- 1210 - Crushed rock material conforming to the requirements of these specifications shall be placed on the approved roadbed and base course in accordance with these specifications and conforming to the lines, grades, dimensions, and typical cross sections shown on the plans. Compacted layers shall not exceed 3 inches in depth. When more than one layer is required, each shall be shaped, processed, compacted, and approved by the Authorized Officer before the succeeding layer is placed. Irregularities or depressions that develop during compaction of the top layer shall be corrected by loosening the material at these places and then adding or removing crushed rock material until the surface is smooth and uniform.

- 1210a - Crushed rock material used to repair or reinforce soft, muddy, frozen, yielding, or rutted roadbed shall not be construed as surfacing required by this specification unless approved by the Authorized Officer.

- 1212 - Each layer of crushed rock material placed, processed, and shaped as specified shall be moistened or dried to a uniform moisture content suitable for maximum compaction and compacted to full width by compacting equipment conforming to

TIMBER SALE ROAD SPECIFICATIONS

the requirements of Subsections 103f and 103i. Minimum compaction shall be 8 passes over each full-width layer, or until visual displacement ceases.

EROSION CONTROL - 1700

- 1701 - This work shall consist of measures to control soil erosion or water pollution during the construction operation through the use of berms, dikes, dams, sediment basins, fiber mats, netting, gravel, mulches, grasses, slope drains, geofabric rolls, and other erosion control devices or methods in accordance with these specifications and conforming to the lines, grades, dimensions and typical cross sections shown on the plans.
- 1703 - This work shall consist of furnishing and installing silt fences, straw bales, geofabric rolls, or similar erosion control devices in accordance with these specifications and in reasonably close conformity with the lines and grades as directed by the Authorized Officer.
- 1703a - Additional erosion control work consisting of furnishing and installing silt fences, straw bales, geofabric rolls, or similar erosion control devices, may be required at the option of the Authorized Officer. Providing that the additional erosion control is not due to Purchaser negligence as specified in Sec. 12 of the contract, a reduction in the total purchased price shall be made to offset the cost of furnishing and installing such additional erosion control devices. Costs shall be based upon the unit price set forth in the current BLM Timber Appraisal Production Cost Schedule.
- 1704 - The erosion control provisions specified under this Subsection shall be coordinated with the Soil Stabilization requirements of Section 1800.
- 1708a - Road segments not completed during dry weather periods shall be winterized, by providing a well-drained roadway using water bars, maintaining drainage, and performing additional measures necessary to minimize erosion and other damage to the roadway, as directed by the Authorized Officer. Portions of roads not having surface rock in place will be blocked or barricaded to prevent vehicular traffic.

TIMBER SALE ROAD SPECIFICATIONS

SOIL STABILIZATION – 1800

- 1801 - This work shall consist of seeding and mulching on designated cut, fill, borrow, disposal, and special areas in accordance with these specifications and as shown on the plans. This work is required for road acceptance under Section 18 of this contract.
- 1802a - Soil stabilization work consisting of seeding and mulching shall be performed on new road construction, road renovation, improvements, landings, and disturbed areas in accordance with these specifications and as shown on the plans.
- 1803 - Soil stabilization work as specified under Subsection 1802a shall be performed during the following seasonal periods:

From: September 1 st	To: October 15 th
---------------------------------	------------------------------

If soil stabilization of disturbed areas is not completed by the specified fall date, the Purchaser shall treat disturbed areas in accordance with Section 1700. The Authorized Officer may modify the above seasonal dates to conform to existing weather conditions and changes in the construction schedule.

- 1803a - The Purchaser shall begin soil stabilization work within 10 days of the starting work date when notified by the Authorized Officer.
- 1804 - The BLM shall provide native grass/forb seed for this project.
- 1806a - Additional soil stabilization work consisting of seeding, and mulching, may be required at the option of the Authorized Officer. Providing the additional stabilization is not due to Purchaser negligence as specified in Sec. 12 of the contract, a reduction in the total purchased price shall be made to offset the cost of furnishing and applying such additional stabilization material. Cost shall be based upon the unit price set forth in the current BLM Timber Appraisal Production Cost Schedule.

TIMBER SALE ROAD SPECIFICATIONS

- 1808 - Mulch materials conforming to the requirements of Subsection 1808a shall be furnished by the Purchaser in the amounts specified under Subsection 1811 and applied in accordance with Subsection 1812.

- 1808a - Straw mulch shall be certified weed free from commercial grain fields and native grass fields. Straw mulch shall be from oats, wheat, rye, or other approved grain crops and shall be free from, mold, or other objectionable material. Straw mulch shall be in an air-dry condition and suitable for placement.

- 1809 - Mulch material shall be delivered to the work area in a dry state. Material found to be wet will not be accepted. Material to be used in the mulching operation may be stockpiled along the road designated for treatment provided that it is maintained in a dry state and has the approval of the Authorized Officer.

- 1810 - Bulk mulching material required under these specifications shall be delivered to the work area bound either by twine, string or hemp rope. Wire binding will not be permitted.

- 1811 - The Purchaser shall furnish and apply to approximately 0.5 acres designated for treatment as shown on the plans and as specified under Subsections 1802a and 1806a, a mixture of grass seed and mulch material at the following rate of application:

Grass Seed	25 lbs./acre
Mulch	2000 lbs./acre

The above proportion and application rate are subject to adjustment by the Authorized Officer during the application operation.

- 1812 - The Purchaser shall furnish and apply to the area designated for treatment as shown on the plans and as specified under Subsections 1802a and 1806a, a mixture of grass seed and mulch material, at the application rate to be determined by the Authorized Officer based on visual observation of trial applications.

TIMBER SALE ROAD SPECIFICATIONS

Mulches shall be spread/placed in treatment areas to a depth of 2 inches to allow seed germination or as directed by the Authorized Officer. Treatment area will be covered evenly and completely. Mulch can be broadcast onto the soil surface by hand or with hand/mechanical operated spreaders.

- 1814 - The Purchaser may reduce the application rate on partially covered slopes and refrain from application on areas already well stocked with grass or on rock surfaces as determined by the Authorized Officer.
- 1815 - The seed and mulch materials shall be placed by the dry method in accordance with the requirements set forth in Subsection 1815b.
- 1815b - Dry Method - Blowers, mechanical seeders, seed drills, landscape seeders, cultipaker seeders, fertilizer spreaders, or other approved mechanical seeding equipment may be used when seed and fertilizer are to be applied in dry form.
- 1819 - The Purchaser shall notify the Authorized Officer at least 3 days in advance of date he intends to commence the specified soil stabilization work.
- 1820 - When sprayed, the mix must overlap on the ground uniformly so that there will be no voids in the treated areas.
- 1821 - Mulch that collects at the end of culverts or accumulates to excessive depths on the slopes shall be evenly spread by hand methods, as directed by the Authorized Officer.
- 1822 - No materials shall be applied when wind velocities would prevent a uniform application of the mix or when winds would drift the mix outside of the designated treatment area.
- 1824 - Twine, rope, sacks, and other debris resulting from the soil-stabilization operation shall be picked up and disposed of to the satisfaction of the Authorized Officer.

TIMBER SALE ROAD SPECIFICATIONS

ROADSIDE BRUSHING - 2100

- 2101 - This work shall consist of the removal of vegetation from the road prism - variable distance, and inside curves in accordance with these specifications and conforming to the lines, grades, dimensions, and typical cross sections shown on the Roadside Brushing Detail Sheet of this exhibit, at designated locations as shown in the plans.
- 2102 - Roadside brushing maybe performed mechanically with self powered, self-propelled equipment and/or manually with hand tools, including chain saws.
- 2103 - Vegetation cut manually and/or mechanically less than 6 inches in diameter when measured 6 inches above the ground shall be cut to a maximum height of 2 inches above the ground surface or above obstructions such as rocks or stumps on cut and fill slopes and all limbs below the 2 inch area will be severed from the trunk.
- 2103a - Vegetation shall be cut and removed from the road bed between the outside shoulders and the ditch centerline and such vegetation shall be cut to a maximum height of 2 inches above the ground and running surface. Limbs below the 2 inch area will be severed from the trunk. Sharp pointed ends will not be permitted. Cuts shall be parallel to the ground line or running surface.
- 2104 - Trees in excess of 6 inches in diameter when measured 6 inches above the ground line shall be limbed, so that no limbs extend into the treated area or over the roadbed to a height of 14 feet above the running surface of the roadway on cut and fill slopes, within the road prism-variable distance. Limbs shall be cut to within 1 inch of the trunk to produce a smooth vertical face. Removal of trees larger than 6 inches in diameter for sight distance or safety may be directed by the Authorized Officer.
- 2105 - Vegetation that is outside of the road prism-variable distance that protrudes into the road prism and within 14 feet in elevation above the running surface shall be cut, to within 1 inch of the trunk to produce a smooth vertical face.

TIMBER SALE ROAD SPECIFICATIONS

- 2106 - Vegetative growth capable of growing 1 foot in height or higher shall be cut, within the road prism-variable distance or as directed by the Authorized Officer.

- 2107 - Inside curves shall be brushed out for a sight distance of 200 feet chord distance or a distance of 15 feet from edge of subgrade, whichever is achieved first. Overhanging limbs and vegetation in excess of 1 foot in height, shall be cut within these areas.

- 2108 - Self propelled equipment shall not be permitted on cut and fill slopes or in ditches.

- 2109 - Debris resulting from this operation shall be scattered downslope from the roadway. Debris shall not be allowed to accumulate in concentrations. Debris in excess of 1 foot in length and 2 inches in diameter shall not be allowed to remain on cut slopes, ditches, roadways or water courses, or as directed by the Authorized Officer.

- 2115 - Mechanical brush cutters shall not be operated when there are people and occupied vehicles within 400 feet of the immediate operating area.

- 2116 - Traffic warning signs shall be required at each end of the work area. Signs shall meet the requirements of the Manual on Uniform Traffic Devices.

UNITED STATES DEPARTMENT OF THE INTERIOR
BUREAU OF LAND MANAGEMENT
ROSEBURG DISTRICT
TIMBER SALE EXHIBIT C

CONTRACT NAME: CONLEY CREEK FIRE SALVAGE
CONTRACT NO: ORR04-TS-2022.0016

ROAD NUMBER	STA/MP TO STA/MP			CONST.	RENOV.	DECOM.	EXISTING SURFACE TYPE	PROPOSED BASE COURSE		PROPOSED SURFACE COURSE		ROAD DIMENSIONS			TYP. ROAD SECTION	SHEET NO.
								DEPTH	TYPE	DEPTH	TYPE	A	B	C		
25-2-21.2	0+00	-	6+50		X		NATIVE	NOTE 2	1004I	6"	1004A	EXISTING	16'	14'	4	5
25-2-27.1	0+00	-	48+85		X		ROCK			NOTE 2	1204C	EXISTING	16'	14'	4	5
	48+85	-	56+00		X		ROCK			4"	1204C	EXISTING	16'	14'	4	5
25-2-28.1	56+00	-	64+00		X		ROCK	NOTE 2	1004I	6"	1004A	EXISTING	16'	14'	4	5
	0+00	-	3+90		X		ROCK					EXISTING	16'	14'	4	5
	3+90	-	9+90		X		ROCK			4"	1204C	EXISTING	16'	14'	4	5
SPUR 1	9+90	-	51+50		X		NATIVE	6"	1004H	3"	1204C	EXISTING	16'	14'	4	5
	0+00	-	5+00		X		NATIVE	6"	1004I	3"	1004A	EXISTING	16'	14'	4	6
SPUR 2	0+00	-	6+30		X		NATIVE	6"	1004A			EXISTING	16'	14'	4	6
SPUR 3	0+00	-	5+00		X		NATIVE	6"	1004A	3"	1204C	EXISTING	16'	14'	4	6

INDEX OF SHEETS	
SHEET	DESCRIPTION
1	ROAD SUMMARY
2	SUMMARY OF QUANTITIES
3	TYPICAL SECTIONS
4	VICINITY MAP
5	RENOVATION NOTES
6	RENOVATION NOTES
7	CULVERT SUMMARY
8	CULVERT INSTALLATION
9	BRUSHING

NOTES:

- SEE EXHIBIT D
- PLACE ROCK COURSES AND SPOT ROCK ONLY AT LOCATIONS SPECIFIED IN RENOVATION NOTES. SEE RENOVATION NOTES FOR DIMENSIONS OR QUANTITIES.



UNITED STATES DEPARTMENT OF THE INTERIOR BUREAU OF LAND MANAGEMENT OREGON STATE OFFICE ROSEBURG DISTRICT	
CONLEY CREEK FIRE SALVAGE ROAD SUMMARY	
DESIGNED: J.RADFORD	DATE: 8/5/2021
CONTRACT NO. ORR04-TS-2022.0016	SHEET 1 OF 9

UNITED STATES DEPARTMENT OF THE INTERIOR
 BUREAU OF LAND MANAGEMENT
 ROSEBURG DISTRICT
 TIMBER SALE EXHIBIT C

CONTRACT NAME: CONLEY CREEK FIRE SALVAGE
 CONTRACT NO: ORR04-TS-2022.0016

ROAD NUMBER	LENGTH	CLEARING AND GRUBBING	ROADSIDE BRUSHING	CLEANING CULVERTS	SURFACING				BLADING	PULLING DITCHES	COMPACTION	CULVERT INSTALLATION (18") ²	CULVERT INSTALLATION (24") ²	CULVERT INSTALLATION (36") ²	EXCAVATION	EMBANKMENT
					1004I	1004A	1004H	1204C								
					6" MINUS	3" MINUS	3" OPEN	1 1/2" MINUS								
	STA/MI	ACRES	ACRES	STA	L.C.Y.	L.C.Y.	L.C.Y.	L.C.Y.	STA/MI	STA/MI	STA/MI	LINEAR FEET	LINEAR FEET	LINEAR FEET	C.Y. (IN-PLACE)	C.Y. (IN-PLACE)
25-2-21.2	6+50	0.12	0.30		100	260			6+50	6+50	6+50					
25-2-27.1	64+00	0.25		64+00	100	330		690	64+00	64+00	64+00					
25-2-28.1	51+50	0.10			10		1800	1020	51+50	51+50	51+50	280			50	50
SPUR 1	5+00				320	100			5+00	5+00	5+00					
SPUR 2	6+30	0.43			370	120			6+30	6+30	6+30	40				
SPUR 3	5+00	0.10			100	200		100	5+00	5+00	5+00					

NOTES
 1. ALL QUANTITIES ARE ESTIMATES AND NOT PAY ITEMS
 2. SEE CULVERT SUMMARY FOR DETAILS



UNITED STATES DEPARTMENT OF THE INTERIOR
 BUREAU OF LAND MANAGEMENT
 OREGON STATE OFFICE ROSEBURG DISTRICT

CONLEY CREEK FIRE SALVAGE
SUMMARY OF QUANTITIES

DESIGNED: J.RADFORD | DATE: 8/5/2021
 CONTRACT NO. ORR04-TS-2022.0016 | SHEET 2 OF 9

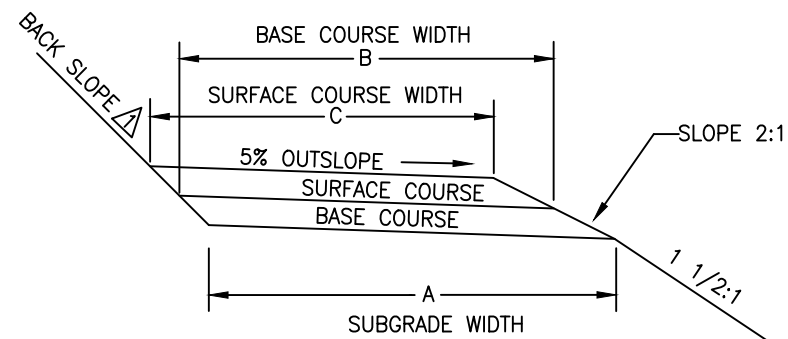

SECTION OUT SLOPE ROAD ①

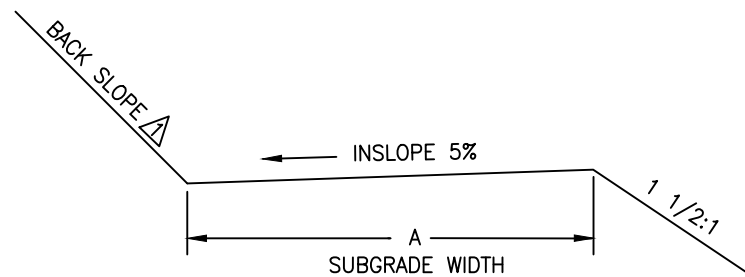

SECTION INSLOPE ROAD ②

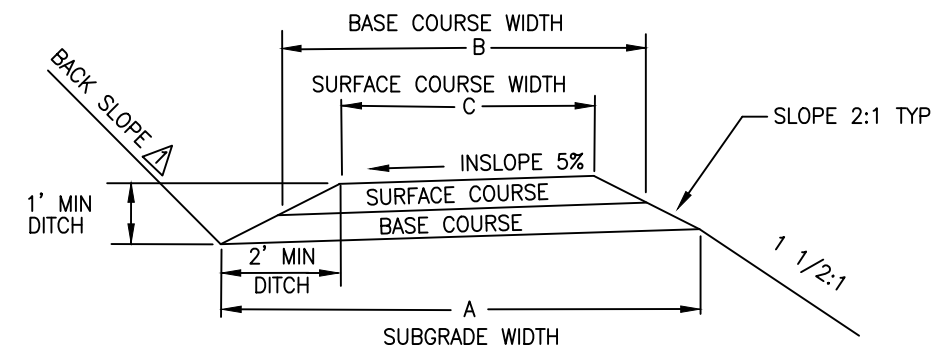

SECTION INSLOPE ROAD ③

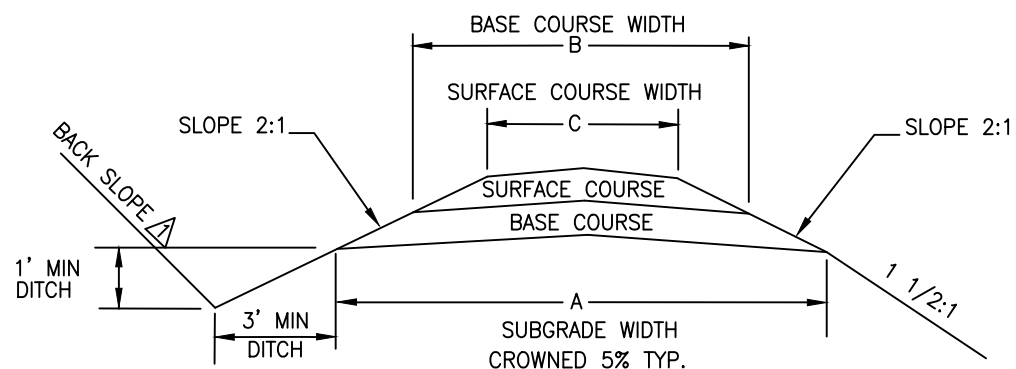

SECTION ROAD ④

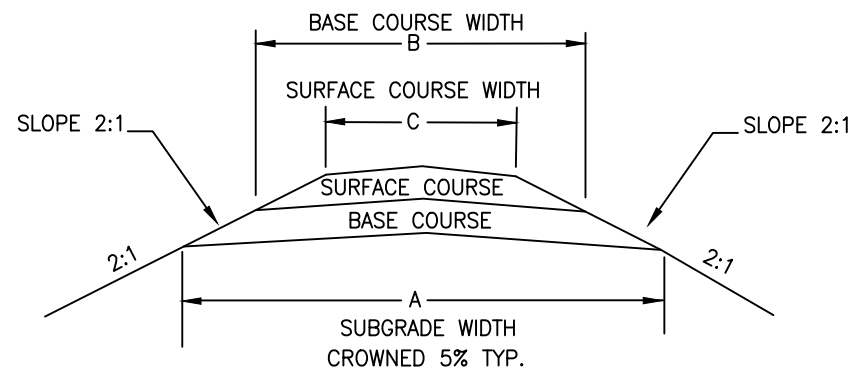

SECTION ROAD ⑤

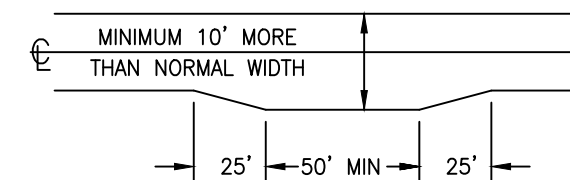

TYPICAL TURNOUT DIMENSIONS

NOTES:

1. Backslope to match existing backslope unless otherwise specified.
2. Backslope for Non-Design Roads:
Slopes under 50%, 3/4:1
Slopes over 50%, 1/2:1
Solid Rock 1/4:1
3. Out slope road segments with grades less than 6%, crown or inslope road segments with grades exceeding 6%.
4. Inslope road sections permitted only for temporary roads. Native surface restricted to summer haul.

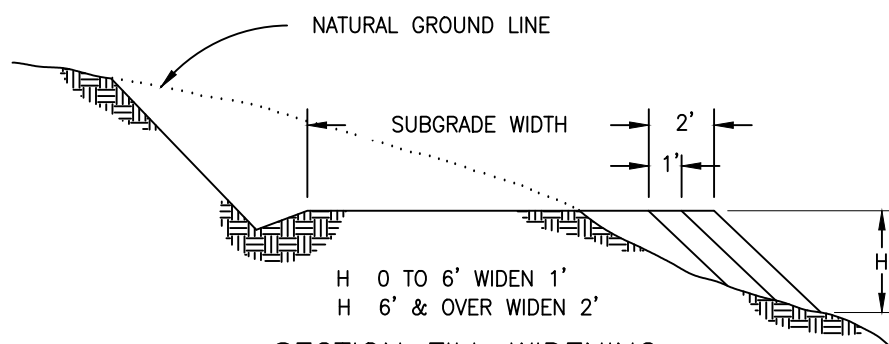

SECTION FILL WIDENING

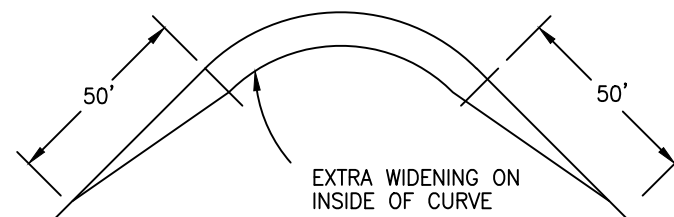

DEGREE OF CURVE	8-21	22-35	36-51	52-64	65-79	80-90
EXTRA WIDTH IN FEET	1	2	3	4	5	6

CURVE WIDENING TABLE FOR NON-DESIGN ROADS OR AS SHOWN ON PLANS. MAX 75' CURVE OR AS SHOWN ON PLANS.



R03W

R02W

Legend

- ⊕ Helicopter Landings
- ⊗ Rock Quarry
- Roads
- ▬ County Road
- ~ Major Stream
- Road Maintenance
- ▬ Road Renovation
- Bureau of Land Management
- Private/Unknown
- Campground Area

T25S

T25S

T26S

T26S

R03W

R02W

HWY 78

GLIDE
10 Miles

Rock Creek
Recreation Site
Campground Area

Lone Pine Recreation Site
Campground Area

Millpond Recreation Site
Campground Area

Rock Creek Access Rd.

26-3-1.0

Spur 1

Spur 2

Spur 3

25-2-20.7

25-2-28.0

25-2-29.5

25-2-28.1

25-2-28.0

25-2-33.1

25-2-33.1

25-2-21.2

25-2-27.1

Harrington Ck.

Miller Ck.

Taylor Ck.

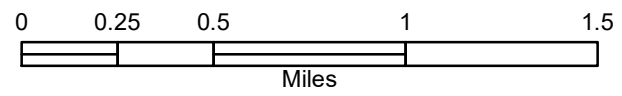

United States Department of the Interior
Bureau of Land Management
Roseburg District
777 NW Garden Valley Blvd
Roseburg, Oregon 97471

Transverse Mercator
Zone 10 North NAD 1983

UNITED STATES DEPARTMENT OF THE INTERIOR
BUREAU OF LAND MANAGEMENT
ROSEBURG DISTRICT OFFICE

CONLEY CREEK FIRE SALVAGE
CONTRACT NO. ORR04-TS-2022.0016

VICINITY MAP

ROAD RENOVATION

Notes:

1. All roads shall be renovated in accordance with attached specifications and the work items listed below. Renovation may include roadside brushing, installing culverts and splash pads, blading, shaping, cleaning ditches, removing slide material, and cleaning existing drainage structures. Features to construct are so noted. Existing features are noted at approximate station in the notes below. The Purchaser shall dispose of all culvert pipe removed as a part of the work described in this contract at a legal site off of BLM land.
2. All renovation and construction shall be done and approved prior to any hauling activity.
3. Existing turnouts, on roads to be renovated, shall be surfaced to the same standard as the adjacent roadway.
4. Back slopes shall be cut to match existing unless otherwise specified.
5. All work shall be performed according to OSHA safety requirements.

<u>MILE POST</u>	<u>DESCRIPTION</u>	<u>MILE POST</u>	<u>DESCRIPTION</u>
	25-2-21.2		25-2-28.1
0+00	BEGIN RENOVATION AT JUNCTION OF ROADS NO. 25-2-21.2 AND THE 25-2-27.1 ROAD BEGIN CLEARING AND GRUBBING, BRUSHING, BLADING, COMPACTING, AND PULLING DITCHES BEGIN SURFACING WITH A 6" LIFT OF 3" MINUS (SPEC. NO. 1004A)	0+00	BEGIN RENOVATION AT JUNCTION OF ROADS NO. 25-2-28.1 AND THE 25-2-20.1 ROAD BEGIN BLADING, COMPACTING, CLEANING CULVERTS, AND PULLING DITCHES
6+50	RENOVATION EXISTING LANDING AND SURFACE LANDING WITH 100 CUBIC YARDS OF 6" MINUS (SPEC. NO. 1004I)	3+90	PROPERTY LINE: ENTER BLM BEGIN SURFACING WITH A 4" LIFT OF 1½" MINUS (SPEC. NO. 1204C)
	25-2-27.1	9+90	REMOVE ROAD BARRIERS END SURFACING WITH A 4" LIFT OF 1½" MINUS (SPEC. NO. 1204C) BEGIN SURFACING WITH A 6" LIFT OF 3" MINUS (SPEC. NO. 1004H) AND BEGIN SURFACING WITH A 3" LIFT OF 1½" MINUS (SPEC. NO. 1204C)
0+00	BEGIN RENOVATION AT JUNCTION OF ROADS NO. 25-2-27.1 AND THE 25-2-33.1 ROAD BEGIN BLADING, COMPACTING, CLEANING CULVERTS, AND PULLING DITCHES BEGIN SURFACING WITH 500 CUBIC YARDS 1½" MINUS (SPEC. NO. 1204C) SPOT ROCK	10+00	INSTALL 18" X 40' CROSS DRAIN CULVERT
27+00	JUNCTION LEFT: UNNAMED SPUR	14+90	INSTALL 18" X 40' CROSS DRAIN CULVERT
27+25	JUNCTION LEFT: UNNAMED SPUR	20+40	INSTALL 18" X 40' CROSS DRAIN CULVERT
39+60	JUNCTION LEFT: UNNAMED SPUR BEGIN BRUSHING	23+90	JUNCTION LEFT: SPUR 2
41+95	PROPERTY LINE: ENTER PRIVATE	28+20	INSTALL 18" X 40' CROSS DRAIN CULVERT WITH SPLASH PAD
48+85	JUNCTION RIGHT: UNNAMED PRIVATE ROAD END SPOT ROCK SURFACING BEGIN SURFACING WITH A 4" LIFT OF 1½" MINUS (SPEC. NO. 1204C)	31+60	INSTALL 18" X 40' CROSS DRAIN CULVERT WITH SPLASH PAD
50+30	PROPERTY LINE: ENTER BLM	34+20	CONSTRUCT TURN OUT RIGHT AND SURFACE WITH 50 CUBIC YARDS OF 1½" MINUS (SPEC. NO. 1204C)
56+00	JUNCTION RIGHT: 25-2-21.2 ROAD END SURFACING WITH A 4" LIFT OF 1½" MINUS (SPEC. NO. 1204C) BEGIN SURFACING WITH A 6" LIFT OF 3" MINUS (SPEC. NO. 1004A)	35+00	INSTALL 18" X 40' CROSS DRAIN CULVERT
61+50	BEGIN CLEARING AND GRUBBING	36+60	JUNCTION LEFT: SPUR 3
64+00	RENOVATE LANDING AND SURFACE WITH 100 CUBIC YARDS OF 6" AGGREGATE (SPEC. NO. 1004A) END RENOVATION OF THE 25-2-27.1 ROAD	39+00	INSTALL 18" X 40' CROSS DRAIN CULVERT
		51+50	END ROAD RENOVATION OF THE 25-2-28.1 ROAD.



UNITED STATES DEPARTMENT OF THE INTERIOR BUREAU OF LAND MANAGEMENT	
OREGON STATE OFFICE	ROSEBURG DISTRICT
CONLEY CREEK FIRE SALVAGE RENOVATION NOTES	
DESIGNED: J.RADFORD	DATE: 8/10/2021
CONTRACT NO. ORR04-TS-2021.0016	SHEET 5 OF 9

ROAD RENOVATION

Notes:

1. All roads shall be renovated in accordance with attached specifications and the work items listed below. Renovation may include roadside brushing, installing culverts and splash pads, blading, shaping, cleaning ditches, removing slide material, and cleaning existing drainage structures. Features to construct are so noted. Existing features are noted at approximate station in the notes below. The Purchaser shall dispose of all culvert pipe removed as a part of the work described in this contract at a legal site off of BLM land.
2. All renovation and construction shall be done and approved prior to any hauling activity.
3. Existing turnouts, on roads to be renovated, shall be surfaced to the same standard as the adjacent roadway.
4. Back slopes shall be cut to match existing unless otherwise specified.
5. All work shall be performed according to OSHA safety requirements.

<u>MILE POST</u>	<u>DESCRIPTION</u>	<u>MILE POST</u>	<u>DESCRIPTION</u>
	SPUR 1		
0+00	BEGIN RENOVATION AT JUNCTION OF ROADS NO. SPUR 1 AND THE 26-3-1.0 (ROCK CREEK ACCESS ROAD) BEGIN BLADING, COMPACTING, AND PULLING DITCHES BEGIN SURFACING WITH A 6" LIFT OF 6" MINUS (SPEC. NO. 1004I) AND BEGIN SURFACING WITH A 3" LIFT OF 3" MINUS (SPEC. NO. 1004A)		
4+00	JUNCTION LEFT: SHOE-FLY SPUR THE SHOE FLY SPUR CAN BE RENOVATED AND ROCKED AT THE OPERATORS/PURCHASES EXPENSE		
5+00	RENOVATE EXISTING 80'X80' LANDING AND SURFACE WITH 100 CUBIC YARDS OF 6" MINUS (SPEC. NO. 1004I) END RENOVATION OF SPUR 1		
	SPUR 2		
0+00	BEGIN RENOVATION AT JUNCTION OF ROADS NO. SPUR 2 AND THE 25-2-28.1 BEGIN GLEARING AND GRUBBINBG, BLADING, COMPACTING, AND PULLING DITCHES BEGIN SURFACING WITH A 6" LIFT OF 6" MINUS (SPEC. NO. 1004I) AND BEGIN SURFACING WITH A 3" LIFT OF 3" MINUS (SPEC. NO. 1004A)		
0+70	INSTALL 18" X 40' CROSS DRAIN CULVERT		
6+30	RENOVATE EXISTING LANDING AND SURFACE WITH 100 CUBIC YARDS OF 6" MINUS (SPEC. NO. 1004I) END RENOVATION OF SPUR 2		
	SPUR 3		
0+00	BEGIN RENOVATION AT JUNCTION OF ROADS NO. SPUR 2 AND THE 25-2-28.1 BEGIN GLEARING AND GRUBBINBG, BLADING, COMPACTING, AND PULLING DITCHES BEGIN SURFACING WITH A 6" LIFT OF 3" MINUS (SPEC. NO. 1004A) AND BEGIN SURFACING WITH A 3" LIFT OF 1½" MINUS (SPEC. NO. 1204C)		
5+00	RENOVATE EXISTING LANDING AND SURFACE WITH 100 CUBIC YARDS OF 6" MINUS (SPEC. NO. 1004I) END RENOVATION OF SPUR 3		



UNITED STATES DEPARTMENT OF THE INTERIOR BUREAU OF LAND MANAGEMENT	
OREGON STATE OFFICE	ROSEBURG DISTRICT
CONLEY CREEK FIRE SALVAGE RENOVATION NOTES	
DESIGNED: J.RADFORD	DATE: 8/10/2021
CONTRACT NO. ORR04-TS-2022.0016	SHEET 6 OF 9

CULVERT LIST

CULVERT LOCATIONS						DOWNSPOUT (NOTE 4)						REMARKS (NOTE 6)		
DESIGNED (NOTE 2)					AS BUILT			DOWNSPOUT (NOTE 4)						
ROAD NO. STATION OR M.P.	MATERIAL (NOTE 7)	SIZE (IN)	LENGTH (FT)	SKEW ANGLE	INSTALL TYPE (NOTE 3)	ROAD NO. STATION OR M.P.	SIZE	LENGTH	MATERIAL	TYPE	SIZE (IN)		LENGTH (FT)	ELBOW TYPE (NOTE 5)
25-2-28.1														
10+00	*	18	40	30	2									
14+90	*	18	40	30	2									
20+40	*	18	40	30	2									
28+20	*	18	40	30	2									INSTALL SPLASH PAD
31+60	*	18	40	30	2									INSTALL SPLASH PAD
35+00	*	18	40	30	2									
39+00	*	18	40	30	2									
Spur 2														
0+70	*	18	40	30	2									

- NOTES:**
- DESIGNED CULVERT LENGTHS AND LOCATIONS ARE APPROXIMATE.
 - ALL CULVERTS HAVE 2 2/3" X 1/2" CORRUGATIONS UNLESS OTHERWISE SPECIFIED.
 - SEE CULVERT INSTALLATION SHEET.
 - DOWN SPOUT TYPES:
 - FULL
 - HALF
 - FLUME
 - ELBOW TYPES:
 - CONVENTIONAL OR FABRICATED
 - TURNER TYPE
 - SLIP JOINT
 - INCLUDE SPECIAL SECTIONS, STRUCTURES, HEADWALLS, FOOTINGS, AND OTHER DATA.
 - MATERIAL TYPES
 - HDPE = HIGH-DENSITY POLYETHYLENE
 - CMP = CORRUGATED METAL PIPE (STEEL OR ALUMINUM)

ROUND PIPE CULVERT		
MATERIAL	SIZE	LENGTH
*	18"	320'

* MATERIAL TYPE: HI-DENSITY POLYETHYLENE OR ALUMINIZED



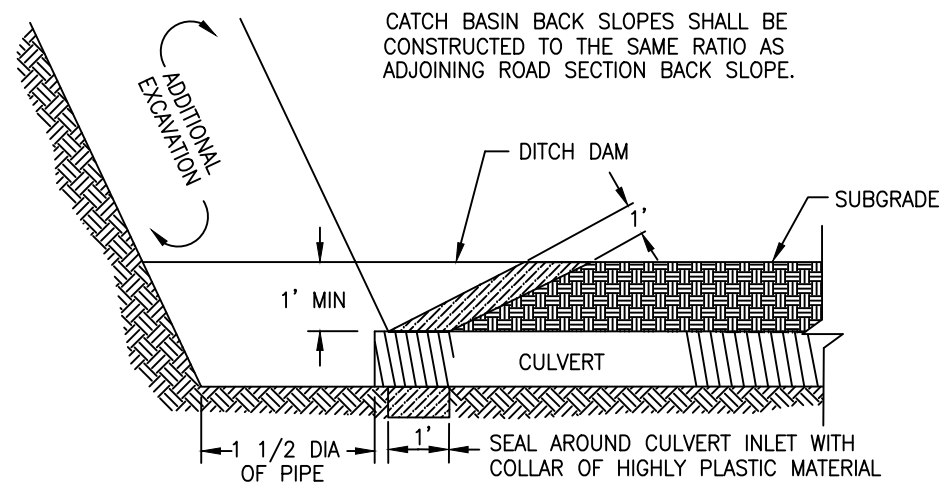

CROSS SECTION AT CATCH BASIN
CULVERT INSTALATION TYPE 2, 3, AND 4

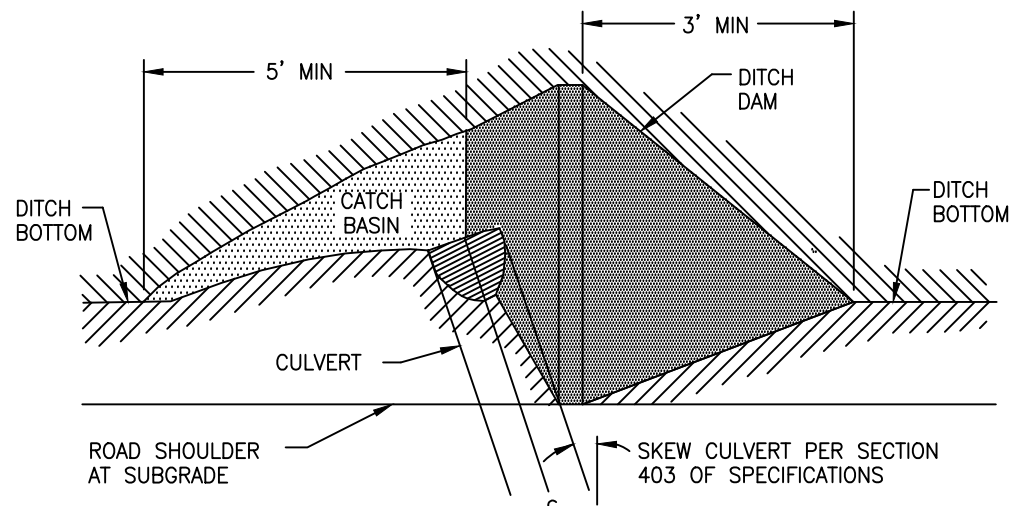

PLAN VIEW

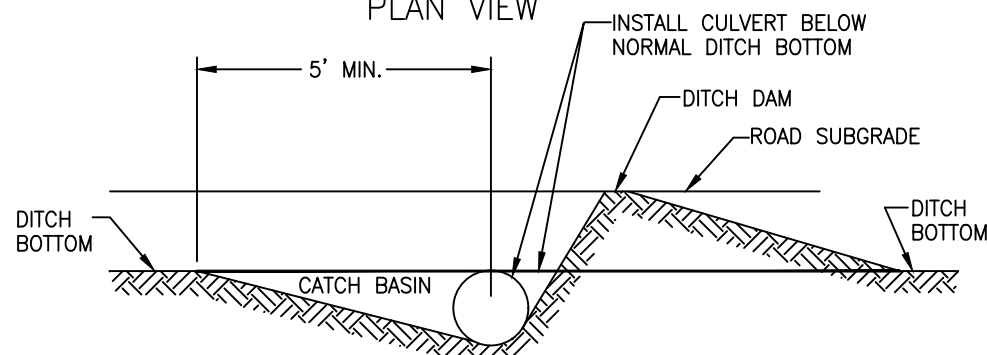

CATCH BASIN ELEVATION

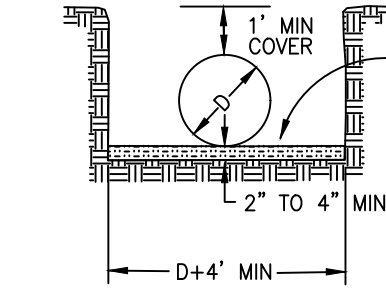
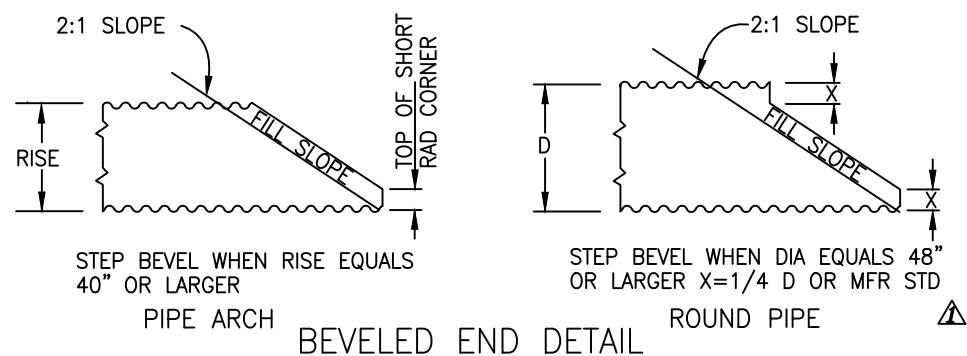

BEDDING OF CULVERTS ON STABLE NATURAL GROUND FOUNDATION

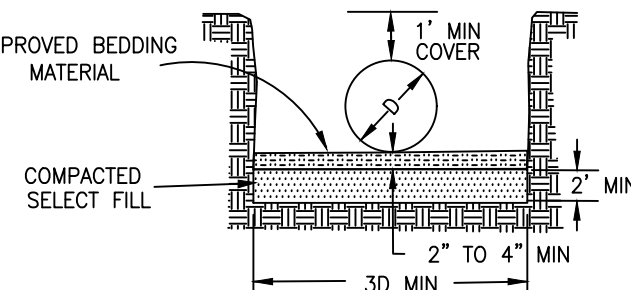

BEDDING OF CULVERTS ON SOFT SPONGY, UNSTABLE SOIL FOUNDATION OR COMPACTED EMBANKMENT

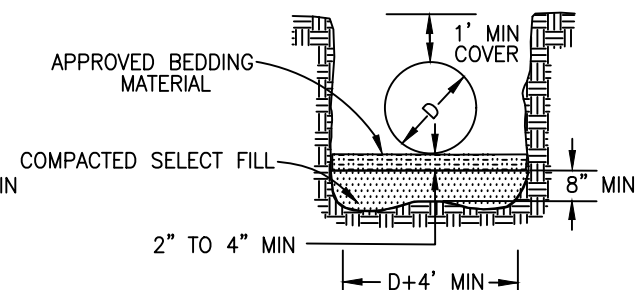

BEDDING OF CULVERTS IN SOLID ROCK OR BOULDER FOUNDATION

NOTES:

1. BEDDING MATERIAL SHALL BE PLACED LOOSE AND SHAPED TO FIT THE BOTTOM OF THE CULVERT
2. BACKFILL IN ACCORDANCE WITH SECTION 417 OF SPECIFICATIONS
3. MAINTAIN 8" MIN DEPTH BETWEEN HIGH POINT OF ROCK AND/OR BOULDERS AND THE BOTTOM OF THE CULVERT BEDDING

BEDDING OF CULVERTS

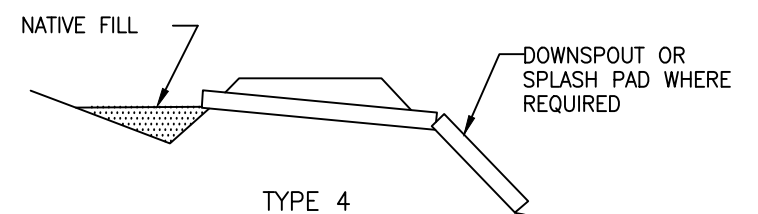
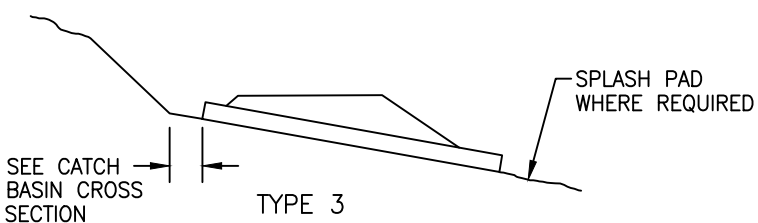
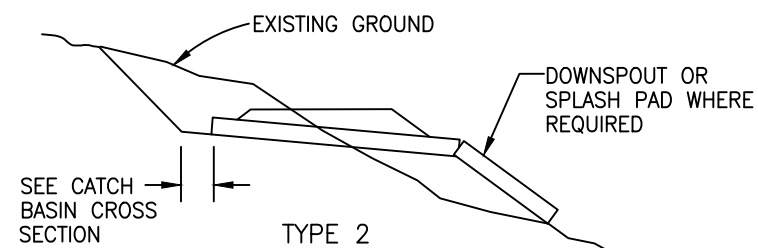
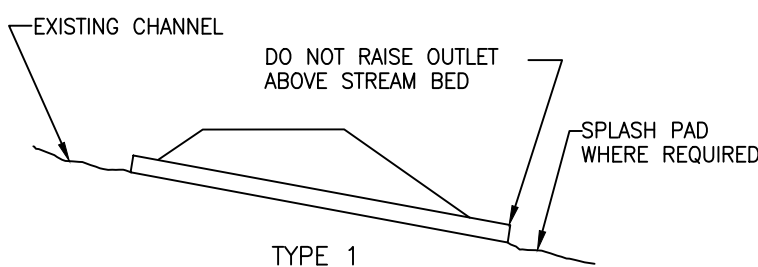

CULVERT INSTALLATION TYPES

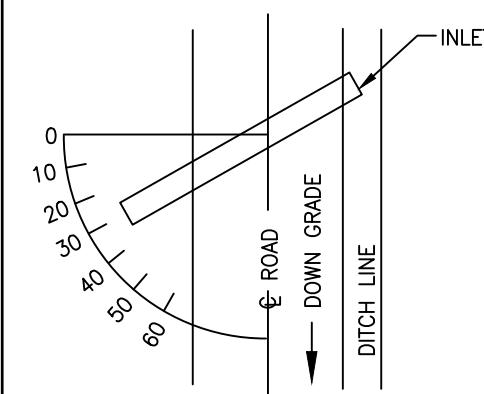
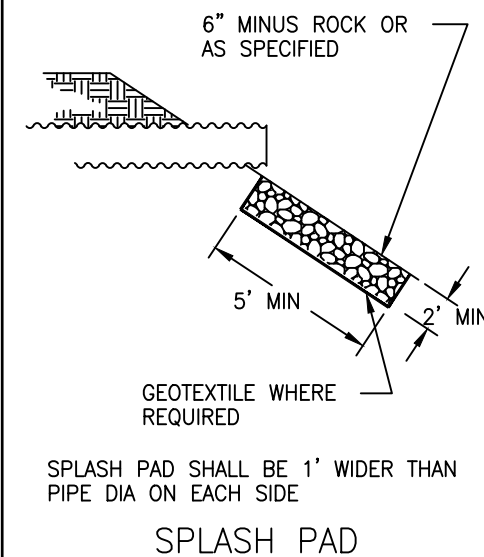

THE GRADE OF CROSS DRAINS SHALL BE AT LEAST 2% GREATER THAN THE GRADE OF THE DITCH

SKEW DIAGRAM

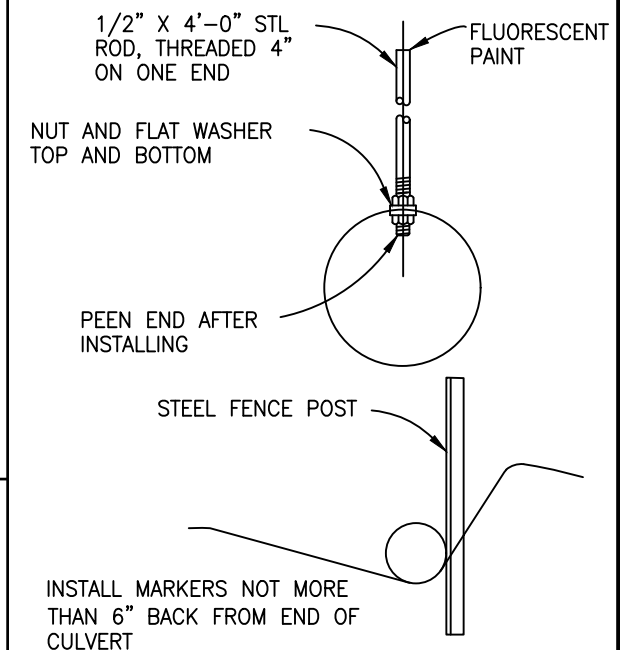

CULVERT MARKER INSTALLATION



NOTE:

1. ALL AREAS WITHIN THE VARIABLE DISTANCE SHALL BE CLEARED OF VEGETATION.
2. ALL AREAS WITHIN THE VARIABLE DISTANCE SHALL BE FREE OF ALL OVERHANGING LIMBS AND BRANCHES WITHIN 14 FEET ELEVATION ABOVE RUNNING SURFACE. 

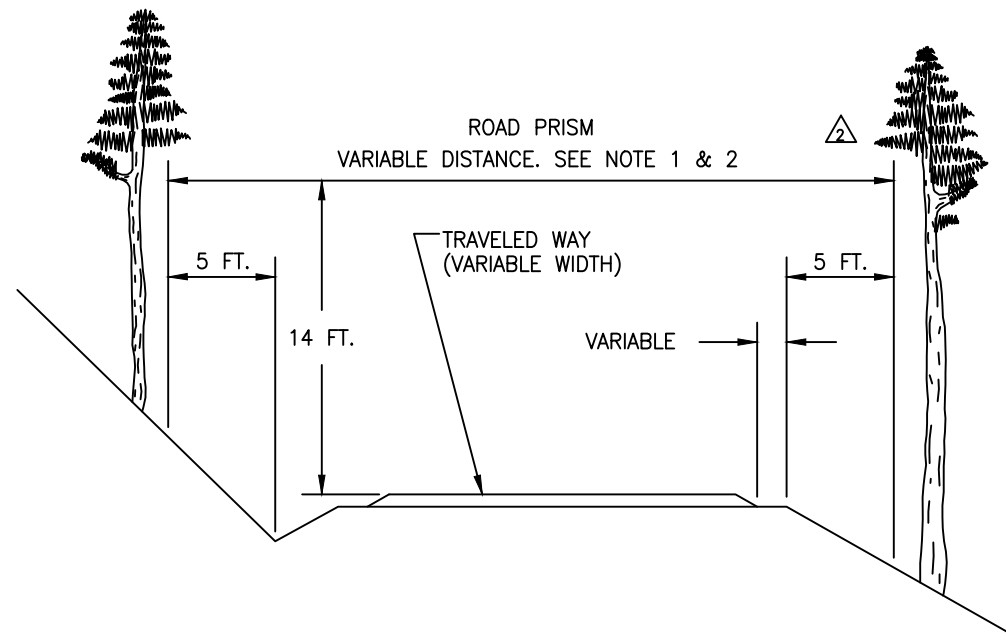

EXAMPLE 1

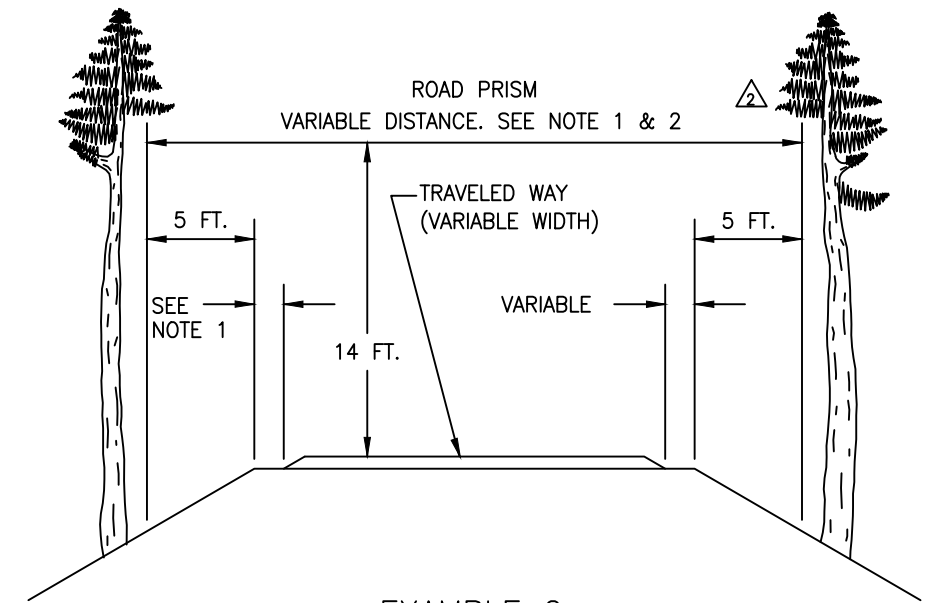

EXAMPLE 2

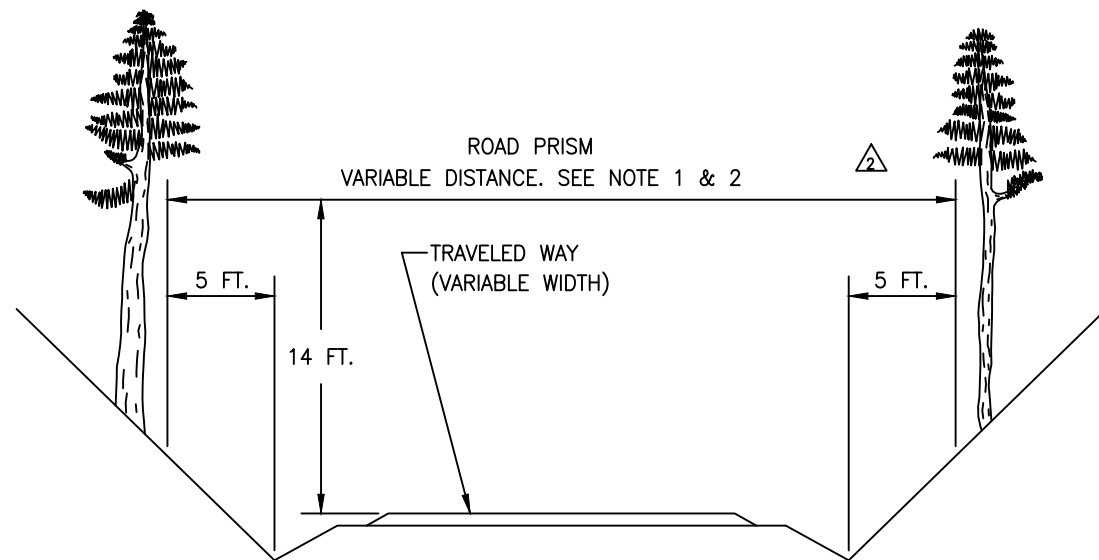

EXAMPLE 3

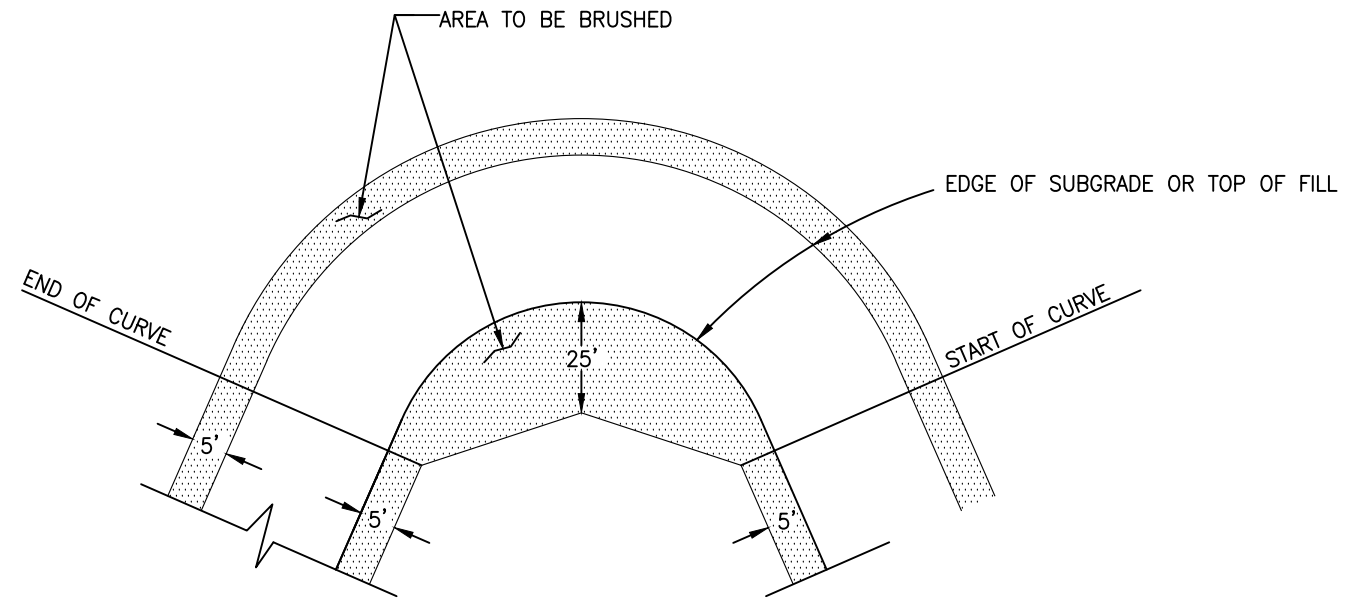

CURVE



UNITED STATES DEPARTMENT OF THE INTERIOR	
BUREAU OF LAND MANAGEMENT	
OREGON STATE OFFICE	ROSEBURG DISTRICT
CONLEY CREEK FIRE SALVAGE	
BRUSHING DETAIL	
DESIGNED: J.RADFORD	DATE: 8/11/2021
CONTRACT NO. ORR04-TS-2022.0016	SHEET 9 OF 9