

Form 1221-2
(June 1969)



UNITED STATES
DEPARTMENT OF THE INTERIOR
BUREAU OF LAND MANAGEMENT

MANUAL TRANSMITTAL SHEET

Release

3-351

Date

10/02/2014

Subject

H-3073-1 Coal Evaluation (P)

1. **Explanation of Materials Transmitted:** This release transmits a new Handbook.
2. **Reports Required:** None.
3. **Materials Superseded:** None.
4. **Filing Instructions:** File as directed below.

REMOVE

All of H-3070-1, Rel. 3-285

(Total: 106 Sheets)

INSERT

All of H-3073, Rel. 3-351

(Total: 80 Sheets)

Mike Nedd, Assistant Director,
Energy, Minerals and Realty Management

This page is intentionally left blank

COAL EVALUATION HANDBOOK



BLM Manual Handbook H-3073-1
U.S. Department of the Interior
Bureau of Land Management

Table of Contents

ACRONYMS..... I

CHAPTER 1. INTRODUCTION.....1

1.1. PURPOSE1

1.2. AUTHORITIES2

1.3. LEASE-BY-APPLICATION PROCESS.....2

1.4. LEASE MODIFICATIONS.....2

1.5. REGULATORY CONCEPTS.....4

 1.5.1. Fair Market Value (FMV).....4

 1.5.2. Maximum Economic Recovery (MER)4

 1.5.3. Ultimate Maximum Recovery of Indian Coal.....5

 1.5.4. Mining Unit (MU)5

1.6. TRACT CONFIGURATION5

CHAPTER 2. EVALUATION TEAM.....1

2.1. INTRODUCTION1

2.2. DUTIES FOR THE EVALUATION TEAM.....1

2.3. FORMATION OF AN EVALUATION TEAM.....2

2.4. EVALUATION TEAM MEMBER SKILLS AND QUALIFICATIONS3

 2.4.1. Required Experience3

 2.4.2. Geological Specialist.....3

 2.4.3. Mine Engineering Specialist.....4

 2.4.4. Economic and Market Specialist.....4

 2.4.5. Mineral Evaluation Analyst.....4

2.5. EVIDENCE OF EVALUATION TEAM SKILLS AND QUALIFICATIONS.....5

2.6. CONTINUING EDUCATION5

CHAPTER 3. DATA REQUIREMENTS.....1

3.1. INTRODUCTION1

3.2. GENERAL DATA REQUIREMENTS1

3.3. ENVIRONMENTAL AND TRACT CONFIGURATION DATA REQUIREMENTS.....2

3.4. PROPERTY STATUS DATA REQUIREMENTS.....2

3.5. GEOLOGIC DATA REQUIREMENTS.....3

3.6. MINE ENGINEERING AND OPERATIONAL DATA REQUIREMENTS.....3

3.7. ECONOMIC AND DOMESTIC COAL MARKET DATA REQUIREMENTS.....5

 3.7.1. General Economic Data.....6

 3.7.2. Specific Lease Tract Economic Data.....6

 3.7.3. Lease-Specific Comparable Sales Data7

3.8. EXPORT COAL MARKET DATA REQUIREMENTS.....8

3.9. DATA SOURCES.....9

3.10. DATA STANDARDS.....9

3.11. COMPUTATIONAL MODELS10

CHAPTER 4. METHODS AND MODELS USED FOR VALUATION.....1

4.1. INTRODUCTION1

4.2. HIERARCHICAL EVALUATION OF COAL PROPERTIES.....1

4.3. APPLICATION OF EVALUATION METHODS TO FEDERAL COAL LEASE TRACTS2

 4.3.1. Valuation of Type 1 Tracts4

 4.3.2. Valuation of Type 2 Tracts4

 4.3.3. Valuation of Type 3 Tracts4

4.4. BUILDING EVALUATION MODELS5

4.5. COMPARABLE SALES6

 4.5.1. Eligible Comparable Sale Transactions.....7

 4.5.2. Ranking Eligible Comparable Sales.....8

| | | |
|--|---|----------|
| 4.5.3. | <i>Special Considerations</i> | 9 |
| 4.5.4. | <i>Selectable Comparable Sales</i> | 10 |
| 4.5.5. | <i>Unadjusted Transactions</i> | 11 |
| 4.5.6. | <i>Adjusted Transactions</i> | 11 |
| 4.5.6.1. | Contract Method | 11 |
| 4.5.6.2. | Regression Analysis..... | 13 |
| 4.5.7. | <i>Reconciliation of Indicated Values</i> | 14 |
| 4.6. | INCOME APPROACH | 14 |
| 4.6.1. | Overview of the Income Approach..... | 15 |
| 4.6.2. | Mine Plan Selection | 15 |
| 4.6.3. | Determining Revenues..... | 15 |
| 4.6.4. | Determining Mining Costs..... | 17 |
| 4.6.5. | Cost Elements | 17 |
| 4.6.6. | Discount Rates | 17 |
| 4.6.7. | Discounted Cash Flow Analysis and Taxes | 17 |
| 4.7. | INCORPORATING UNCERTAINTY IN THE VALUATION PROCESS | 18 |
| 4.7.1. | Sensitivity Analysis | 18 |
| 4.7.2. | Probability Weighted Scenario | 19 |
| 4.7.2.1. | Decision Tree Analysis | 20 |
| 4.7.3. | Monte Carlo DCF Analysis | 20 |
| 4.8. | COMPUTER MODELS FOR MINERAL PROPERTY VALUATION..... | 21 |
| 4.8.1. | Mine Simulation and Costing Algorithms | 21 |
| 4.8.2. | DCF Computer Programs | 22 |
| 4.8.3. | Monte Carlo DCF Computer Program..... | 22 |
| 4.8.4. | Other Additional Modeling Software..... | 22 |
| CHAPTER 5. PREPARATION OF THE PRE-SALE VALUATION REPORT | | 1 |
| 5.1. | INTRODUCTION | 1 |
| 5.2. | VALUATION REPORT..... | 1 |
| 5.2.1. | <i>Summary Page</i> | 1 |
| 5.2.2. | <i>Evaluation Summary</i> | 2 |
| 5.2.3. | <i>Signature Page</i> | 2 |
| 5.2.4. | <i>Table of Contents</i> | 2 |
| 5.2.5. | <i>Introduction</i> | 2 |
| 5.2.6. | <i>Tract and Legal Land Description</i> | 2 |
| 5.2.7. | <i>Tract Data</i> | 2 |
| 5.2.8. | <i>Analysis</i> | 3 |
| 5.2.9. | <i>Overview</i> | 3 |
| 5.2.10. | <i>Value Estimated by the Comparable Sales Approach</i> | 3 |
| 5.2.11. | <i>Data Acquisition</i> | 4 |
| 5.2.12. | <i>Data Analysis</i> | 4 |
| 5.2.13. | <i>Comparison Factors</i> | 4 |
| 5.2.14. | <i>Adjustments</i> | 5 |
| 5.2.15. | <i>Reconciliation of Comparable Values</i> | 5 |
| 5.2.16. | <i>Value Estimated by Income Approach</i> | 5 |
| 5.2.17. | <i>References (Source Citation Format)</i> | 6 |
| CHAPTER 6. REVIEW OF THE PRE-SALE ESTIMATE FMV..... | | 1 |
| 6.1. | INTRODUCTION | 1 |
| 6.2. | COMPLETION AND TRANSMITTAL OF THE PRE-SALE FMV REPORT..... | 1 |
| 6.3. | REPORT REVIEW STANDARDS..... | 1 |
| 6.3.1. | <i>Comparable Sale Data</i> | 1 |
| 6.3.2. | <i>Constraints</i> | 1 |
| 6.4. | COAL VALUATION REVIEW PROCEDURES..... | 1 |
| 6.4.1. | <i>Supporting Documentation Review</i> | 2 |
| 6.4.2. | <i>Document the Pre-sale Valuation Report Review</i> | 2 |
| 6.5. | ARBITRATION TEAM | 2 |

6.6. LEASE OFFER3

CHAPTER 7. POST LEASE SALE PROCESS.....1

7.1. SALE PANEL.....1

7.2. SCREEN BIDS FOR MINIMUM QUALIFICATIONS1

7.3. BID ACCEPTANCE CRITERIA1

7.4. POST-SALE VALUATION REPORT1

7.5. DME/OVS CLOSURE MEMORANDUM2

CHAPTER 8. PROPRIETARY AND CONFIDENTIAL INFORMATION.....1

8.1. TRANSPARENCY1

8.2. GENERAL REQUIREMENTS1

8.3. THE MINERAL LEASING ACT, AS AMENDED.....2

8.4. COAL LEASE FORM (BLM-3400-12)2

8.5. PENALTIES FOR THE UNAUTHORIZED RELEASE OF PROPRIETARY OR CONFIDENTIAL BUSINESS
INFORMATION AND VIOLATION OF THE TRADE SECRETS ACT2

8.6. INDIAN LANDS3

8.7. FOIA AND CONFIDENTIAL, PROPRIETARY INFORMATION.....3

8.8. SECURITY.....4

8.9. CHAIN OF CUSTODY4

GLOSSARY1

APPENDIX A: DEFENSIBILITY OF LINEAR REGRESSION ANALYSIS1

APPENDIX B: HISTORY OF FEDERAL COAL FAIR MARKET VALUE ESTIMATION1

Acronyms

| | |
|---------------|---|
| BIA | Bureau of Indian Affairs, Department of the Interior |
| BLM | Bureau of Land Management, Department of the Interior |
| Btu | British Thermal Unit |
| DCF | Discounted Cash Flow |
| DME | Division of Minerals Evaluation, Office of Valuation Services, Department of the Interior |
| DOD | Department of Defense |
| DSD | BLM Deputy State Director |
| FCLAA | Federal Coal Leasing Amendments Act |
| FMV | Fair Market Value |
| FOIA | Freedom of Information Act |
| FWS | Fish and Wildlife Service, Department of the Interior |
| GIS | Geospatial Information System |
| GPS | Geographic Positioning System |
| ET | Evaluation Team |
| IB | Information Bulletin |
| IM | Instruction Memorandum |
| LBA | Lease-by-Application |
| LMU | Logical Mining Unit |
| LR2000 | Legacy Rehost 2000 System |
| MER | Maximum Economic Recovery |
| MLR | Multiple Linear Regression |
| MOU | Memorandum of Understanding |
| MS | Manual Section |
| MSHA | Mine Safety and Health Administration, Department of Labor |
| MU | Mining Unit |
| NEPA | National Environmental Policy Act |
| NPS | National Park Service, Department of the Interior |
| NPV | Net Present Value |
| ONRR | Office of Natural Resources Revenue (formerly a unit of the bureau known as the Mineral Management Service - MMS) |
| OSM | Office of Surface Mining Reclamation and Enforcement, Department of the Interior |
| OVS | Office of Valuation Services, Department of the Interior |
| SD | BLM State Director |
| SMA | Surface Management Agency |
| SMCRA | Surface Mining Control and Reclamation Act |
| SRA | State Regulatory Agency |
| UMR | Ultimate Maximum Recovery |
| USFS | U.S. Forest Service, Department of Agriculture |
| USGS | U.S. Geologic Survey, Department of the Interior |

Chapter 1. Introduction

1.1. Purpose

This handbook provides procedures and guidance for valuation of Federal coal offered for leasing. The uniform application of these procedures will provide consistent and replicable valuation results. The term Federal coal property, as used in this handbook, refers specifically to Federal interests in coal deposits proposed for lease or lease modification.

This handbook is not intended to be used for valuation of Federal coal property proposed for sale, exchange, or title transfer. The Bureau of Land Management (BLM) is required to obtain fair market value when leasing the Federal coal property. The Department of the Interior (DOI) Secretarial Order 3300, May 21, 2010, and DOI Manual 112 DM 33, June 1, 2011, delegated to the Office of Valuation Services (OVS), under the Secretary of the Interior, the authority to estimate Fair Market Value (FMV) of real property and minerals, including Federal coal property, for the purposes of sale, exchange, or other forms of title transfer. Although many of the procedures, processes, and terms used in this handbook are intentionally similar to those that would be used to value the coal for sale, exchange, or title transfer transaction of the minerals or property, this handbook is intend solely for the valuation of coal for leasing or modification of a coal lease.

The amount, type and quality of available data are the primary factors considered to determine what methods are used to estimate the pre-sale FMV. A complete and well-documented valuation report must contain or reference all supporting facts and data, as well as document and explain assumptions, analyses and conclusions to the extent that the valuation estimate can be independently verified.

This handbook provides a hierarchical methodology for determining a pre-sale estimate of the value of a prospective coal lease. The hierarchal methodology structures the valuation analysis to apply the most reliable valuation approach using the available data. The hierarchical methodology uses two primary approaches:

- The comparable sales approach: The prices paid in prior transactions for similar coal properties are used to value the prospective Federal coal property to be leased. This method is preferred because the prices that were paid in prior transactions for similar coal properties provide the most reliable indication of value; and
- The income approach: The realistic estimation of future annual revenues and costs associated with the development of the coal property, which are reduced (or discounted) to a single (net present) value that provides an estimate of the property's present net income potential.
- Regulatory minimum value: The value is based on the regulatory minimum value that can be received by Treasury for a coal lease (43 CFR 3422.1(c)(2)). The minimum regulatory value will be used only when other methods of estimating value yield results that are less than the equivalent of \$100 per acre.

Nothing in this handbook is intended to be a regulation or to modify or amend any Federal laws or regulations or create any rights or cause of action or trust obligation enforceable by any person

or party through litigation or otherwise against the United States Government or any of its employees. This Handbook is solely intended to aid in the coal valuation and management program of the BLM. To the extent that there is any inconsistency between the provisions of this handbook and any Federal regulations or laws, the regulations or laws will supersede this handbook.

1.2. Authorities

The BLM's authority to manage coal leasing on Federal lands comes from the Mineral Leasing Act of 1920, 30 U.S.C. §§ 181 *et seq.* (MLA), as amended and other laws listed in 43 CFR 3400.0-3. Other authorities include:

- 25 CFR 211.4, 212.4, and 225.4 - Authority and responsibility of the Bureau of Land Management (BLM);
- 43 CFR Part 3400 - Coal Management: General and the legislative and statutory authorities cited therein;
- 43 CFR Part 3420 - Competitive Leasing;
- 43 CFR Subpart 3425--- - Leasing on Application;
- 43 CFR Subpart 3432 - Lease Modifications;
- 43 CFR Part 3460 - Environment;
- 43 CFR Part 3480 - Coal Exploration and Mining Operations Rules; and
- 43 CFR Part 3590 - Solid Minerals (other than coal) Exploration and Mining Operations.

1.3. Lease-by-Application Process

Determining the pre-sale FMV estimate of a Federal coal property is one of many integral parts of the lease-by-application process described in 43 CFR Subpart 3425. The Federal coal lease-by-application process involves an extensive procedure that is illustrated by Figure 1.1. The leasing process includes consultation with the State Governor, completion of an environmental analysis under the National Environmental Policy Act (NEPA), review for compliance with established land use plans, review for unsuitability for mining under 43 CFR Subpart 3461, analysis of maximum economic recovery, several opportunities for public outreach, and establishment of the pre-sale FMV estimate.

After a lease sale, the high bid and high bidder are evaluated to determine:

- If the bid met or exceeded the pre-sale FMV estimate (43 CFR 3422.1(c)(1));
- If the high bidder is qualified to hold a Federal coal lease (43 CFR Subpart 3472);
- If the Department of Justice review of the high bidder's assets comply with antitrust requirements (43 CFR 3422.3-4); and
- If the high bidder has provided a sufficient surety bond (43 CFR Subpart 3474)(see MS-3474).

1.4. Lease Modifications

A Federal coal lessee may request the addition of up to 960 acres be added to an authorized Federal coal lease through a lease modification, 43 CFR Subpart 3432. A lease modification is a non-competitive lease sale, but the lessee is required to pay FMV for the additional Federal lands, 43 CFR 3432.2(c). Therefore, this Handbook in its entirety is applicable to the determination of FMV for lease modifications.

**Figure 1.1
Federal Lease-By-Application Process**

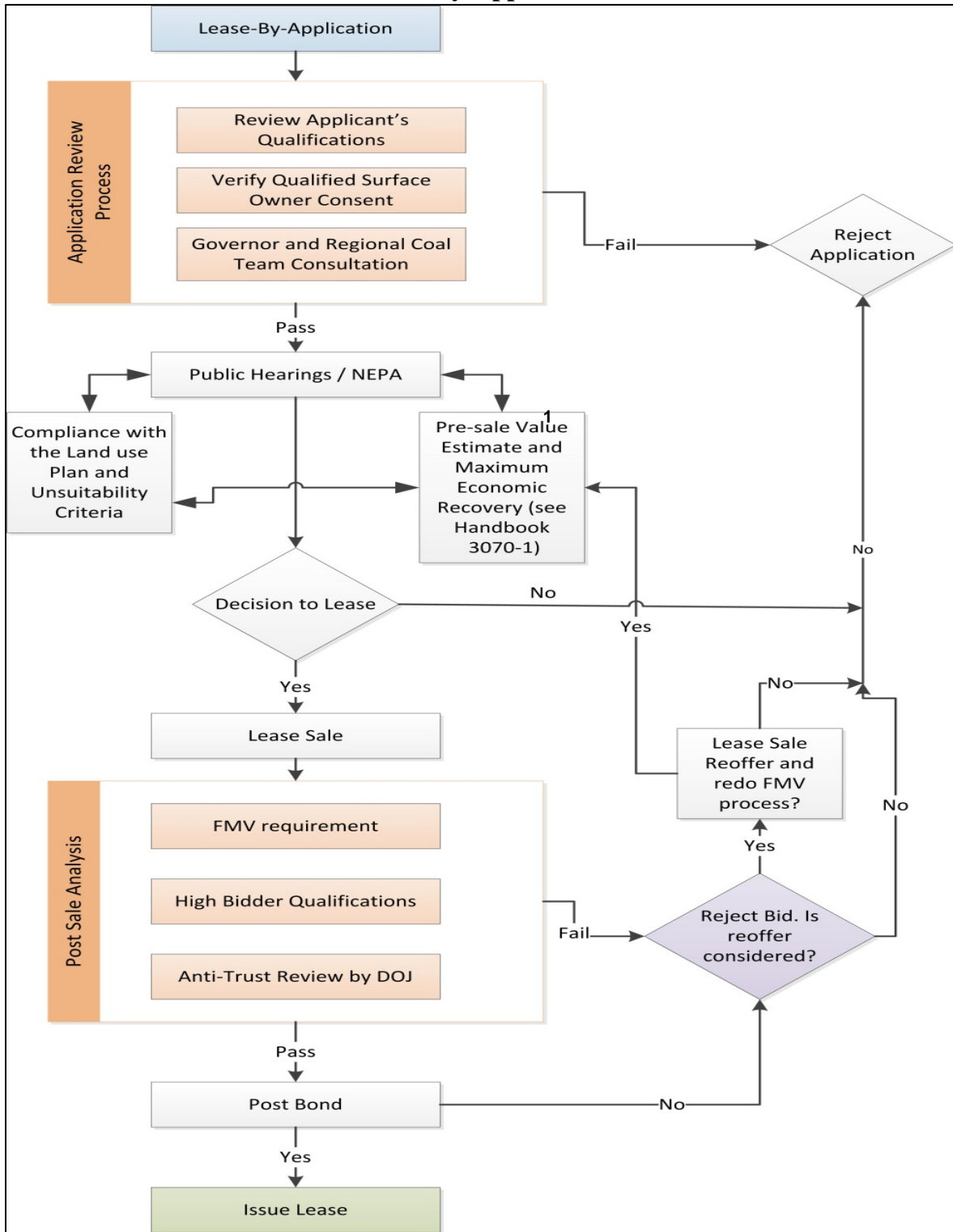

1.5. Regulatory Concepts

1.5.1. Fair Market Value (FMV)

A valuation analysis is focused upon the determination of a pre-sale estimated FMV of a Federal coal property. Under the Federal Coal Leasing Amendments Act (FCLAA), the Secretary of the Interior must not accept a bid that is less than the FMV of the coal within the lease. The regulatory definition of FMV (43 CFR 3400.0-5(n)) provides:

Fair market value means that amount in cash, or on terms reasonably equivalent to cash, for which in all probability the coal deposit would be sold or leased by a knowledgeable owner willing but not obligated to sell or lease to a knowledgeable purchaser who desires but is not obligated to buy or lease.

The salient features of fair market value are:

- The FMV is characterized as, or is representative of, a transaction between a knowledgeable buyer and a knowledgeable seller.
- Neither the buyer nor the seller is obligated or under duress to buy or sell.
- The FMV is determined by reference to a competitive market rather than to the personal or inherent value of the property.
- The property is exposed to a competitive market for a reasonable time.
- The market value is only that value transferable from owner to owner; in most cases this means private market value.
- A property for which there is no competitive interest, but which can likely become part of a larger competition property, can be valued based on being a part of a larger property.

1.5.2. Maximum Economic Recovery (MER)

A valuation analysis using the income approach requires knowledge of the geology of the coal reserve and how much of the coal reserve is economically recoverable. An income approach analysis predicated on the recovery of coal reserves that are not economically recoverable will yield unreliable estimates of value. Therefore, it is critical for an analyst and Evaluation Team (ET) to have a complete knowledge of maximum economic recovery (MER) for Federal coal lands.

The regulations concerning MER of Federal coal (43 CFR 3480.0-5) prescribe that, based on standard industry operating practices, all profitable portions of the coal deposit must be mined. MER defines the maximum limit or extent of profitable mining. MER is an economic test based on when the direct mining, beneficiation, and royalty and tax costs for producing the next unit of coal into a marketable condition, are equal to the value derived from the sale of the same unit of coal. Said another way, the revenue from the sale of each incremental ton of coal must meet or exceed the direct costs to mine, transport, beneficiate, and pay royalty and taxes incurred to produce the next incremental ton of coal mined. MER is achieved at the point where economically recoverable reserves become uneconomical. Therefore, the extent of economical reserve can be determined from the breakeven point, the place profit becomes zero and further mining would not be profitable. The breakeven point can be determined by an incremental analysis where costs are exactly equal to revenue and there is no consideration for an incremental profit margin, rate of return, or amortization of sunk costs.

The MER definition and requirement is restricted to Federal coal and does not apply to Indian lands (43 CFR 3480.0-4).

1.5.3. Ultimate Maximum Recovery of Indian Coal

Similar to required knowledge of MER for Federal coal lands, an analyst or ET must have knowledge on ultimate maximum recovery when valuing a coal lease on tribal lands.

The Bureau of Indian Affairs (BIA) regulations at 25 CFR 211.4, 212.4, and 225.4, governing the authority and responsibility of the BLM for leasing of tribal lands for mineral development, incorporate, through an explicit cross-reference, the BLM regulations at 43 CFR Parts 3480 and 3590, which respectively govern exploration and mining operations for coal and solid, leasable minerals. Unless expressly exempted, the provisions contained in 43 CFR Parts 3480 and 3590 apply to Indian coal lands. The BIA regulations equally apply 43 CFR Part 3480 and 3590 to Indian land without restrictions to the type of mineral. However, the BLM regulations at 43 CFR 3480.0-4 further provide that the provisions of Part 3480 relating to advance royalty, diligent development, continued operation, maximum economic recovery (MER), and logical mining units (LMUs) do not apply to Indian lands, leases, and permits. Therefore, for Indian lands, the BLM's regulations for MER (43 CFR 3480.0-5(a)(21)) do not apply to Indian lands.

The BLM's ultimate maximum recovery (UMR) regulation (43 CFR 3590.0-5(h)) extends to the oversight of all minerals on Indian lands because 43 CFR 3590.0-7 provides that the 43 CFR Part 3590 regulations "also govern operations for all minerals on Indian tribal lands and allotted Indian lands leased under 25 CFR parts 211 and 212." The MER standard at 43 CFR 3400.0-5(a)(21) for Federal coal and the UMR standard at 43 CFR 3590.0-5(h) achieve similar management objectives.

Therefore, consistent with BLM's obligations to maximize recovery under Indian leases, MER or an equivalent concept is important for effective resource management and development of Indian coal. Consequently, to achieve maximum recovery of coal on Indian lands, the BLM manages Indian coal development by applying the UMR regulations found in 43 CFR Part 3590. See 43 CFR 3590.0-5(h); 43 CFR 3590.0-7; 43 CFR 3594.1.

1.5.4. Mining Unit (MU)

The value of a proposed lease can be dependent on existing development or common ownership in adjoining properties. In such cases, the prospective lease must be evaluated based on a mining unit (MU) that would include the proposed lease and any existing infrastructure and ownership on adjoining lands. An MU is a property that is under common control for the purpose of a mining operation that can encompass Federal and non-Federal coal lands, and that in total and in common can be developed and mined in an efficient, economic, and orderly manner with due regard for MER of the Federal coal and conservation of other resources.

1.6. Tract Configuration

An application for a new coal lease or lease modification will contain a description of the requested lands. The BLM has authority to alter the tract configuration as needed (43 CFR

3425.1-9) for reasons the BLM determines to be of public interest. In the configuration process, the BLM will review the requested lands, and a few alternative configurations, in the environmental analysis conducted under the National Environmental Policy Act (NEPA) for the prospective lease. The final tract configuration will be documented in the Record of Decision (ROD) following completion of the environmental analysis. Some considerations for alternative tract configurations can include:

- Providing development potential to as many potential bidders as possible;
- Encompassing as much Federal coal as possible that can currently be economically developed and assure consistent application of MER principles;
- Accommodating other prior existing rights, resource requirements, or land use planning requirements;
- Not allowing any portion of the coal deposit to be stranded into isolated tracts that are too small to be economically developed independently or in combination with other adjoining mining operations; and
- Assuring that all economically recoverable Federal coal resources outside of a tract configuration may be efficiently mined by other adjoining or future mining operations. Refer to section 4.2.

Chapter 2. Evaluation Team

2.1. Introduction

Creating a complete valuation report for a mineral commodity is a complex task that requires integration of many specialized skills. Advanced geologic, engineering, economic, and valuation information must be aggregated and professionally analyzed. Environmental and legal expertise is also required as these functions play a role in the configuration of the coal tract offered for sale and analysis of associated mitigation costs.

The DOI may contract for services to aid in the development of an estimate of mineral value, but the contractor must meet the same or similar qualification requirements as BLM staff that perform similar duties.

A team approach will assure that the necessary critical skills are available to facilitate completion of a valuation report. An Evaluation Team (ET) is the vehicle to integrate all the skills required to complete a Federal coal evaluation. A typical ET is comprised of a geologist, a mine engineer, an economist, a mineral evaluation analyst, and a peer reviewer. An ET may have participants from multiple BLM offices. Based on the experience of the persons appointed to the ET, one person may serve in several capacities. However the peer reviewer must always be a person or entity who has not been involved in the evaluation.

In addition, the analysis of pre-sale FMV estimate must be reviewed by individuals that are knowledgeable and familiar with mineral evaluation methods and procedures, but that have not been involved in the development of the mineral valuation that they are asked to review.

2.2. Duties for the Evaluation Team

The ET must determine the appropriate information and work-flow required to prepare a valuation report. This may require local, regional, state-wide, or industry-wide data and information to develop a comprehensive geologic, engineering, and market analysis for the coal property being evaluated. Any limitations in the scope of analysis (e.g. only having state-wide information) must be described as to why certain geologic, engineering, and market criteria were used in the analysis.

The Evaluation Team will:

- Perform market research, obtain relevant information and justify the use of that data;
- The reported information must be based on accurate data, logical reasoning, and should include sufficient data and supportable analysis to justify the analyst's estimation of the pre-sale FMV;
-
- Determine the most appropriate valuation approach based on available data, including whenever reasonable, adjustments made to reflect current markets and conditions;
- Identify current and future land use planning requirements or restrictions;
- Identify the availability and quality of resources other than coal within the tract;
- Gather and review coal development scenarios relevant to the subject property and compare them to other known operations;
- Gather and review relevant geologic and engineering information to ensure that there is

sufficient information to support the evaluation, such as:

- Data from nearby exploration licenses or other geologic information, such as previous exploration or developmental drilling;
- Confidential business information, such as the mine sequence, mine costs, labor costs, etc.;
- Published sources of geologic data; and
- Published sources of mine costs, equipment capabilities;
- Prepare geologic, engineering, economic, and market information and reports to support valuation;
- Integrate requirements from environmental documents and other site-specific information into the valuation analysis as needed, such as the environmental analysis or applicable requirements for the permit under the authority of the Surface Mining Control and Reclamation Act for an adjoining mine;
- Delineate each tract based on the geologic, engineering, environmental and other pertinent factors;
- Gather relevant information to evaluate the coal market opportunities;
- Gather regional information to evaluate the coal market (such as transportation capacity and demand for new coal leases);
- Analyze the coal market to assess the quality and value for known coal sales of similar severed coal, including analysis of export potential;
- Analyze and quantify risks and uncertainty related to geology, mining, market, and other variables related to the evaluation;
- Document data sources and assumptions;
- Document the rationale for each conclusion;
- Assure all proprietary and confidential data is properly identified and protected;
- Assure that all chapters or supporting reports contain a statement that describes and quantifies the accuracy and adequacy of the data they contain; and
- Assure all sensitive, proprietary, or confidential information is specifically identified in all final reports.

The ET must also make certain that all questions concerning the data are resolved (apart from any attempt to change the reported FMV estimate) by the Deputy State Director (DSD) or delegated line officer.

2.3. Formation of an Evaluation Team

An ET is comprised of persons or contractors who have the skills required for the successful completion of a specific valuation. An ET must be identified at the beginning of each valuation, typically upon acceptance of an application for a lease or lease modification, so that the ET can be involved in all aspects of processing the application. The DSD for Mineral Resources, or delegated line officer of BLM, is responsible for identifying and procuring the persons and other resources required for each valuation. The DSD should also identify and secure staffing for peer review of the analysis when the ET is formed. Lastly, coordination with the Division of Minerals Evaluation, Office of Valuation Services, Department of the Interior (DME) about its review time should occur early in the process.

2.4. Evaluation Team Member Skills and Qualifications

The ET must be comprised of persons with relevant experience in estimation of the quantity of mineral reserve, mine plan development, evaluation of mineral value, and specific training and experience in:

- Analysis of coal quality and quantities;
- Development of mine design;
- Evaluation of maximum economic recovery to determine the economic extent of mining;
- Development of mine capital and operating costs projections;
- Analysis of cash flow;
- Evaluation of the mineral property's development risks and strategic position;
- Evaluation of domestic and international markets for the severed coal;
- Analysis of comparable sales and of performing discounted cash flow analysis to estimate property value; and
- The ability to present all the data, analysis and conclusions in a logical, concise, and well-documented format.

The results of a legal and cadastral review of lands applied for and the potential environmental impact associated with leasing the lands are considered when determining tract configuration and may influence mining methods or costs. Therefore, the ET should also include a Land Law Examiner familiar with solid leasable mineral actions and a Project Lead for the lease application's environmental document (usually an Environmental Specialist or Natural Resource Specialist).

2.4.1. Required Experience

Unless noted otherwise for a particular professional specialty, each specialist assigned to an ET, regardless of their individual specialty and educational accomplishments must have minimum relevant experience performing mineral evaluation tasks commensurate with their highest level of completed education as shown in Table 2.1. Analysts under contracted work agreements must also comply with these requirements.

Table 2.1.
Minimum Required Experience

| Highest Level of Education Attained | Bachelor's Degree | Advanced Degree |
|--|-------------------|-----------------|
| Minimum Required Applicable Experience | 4 Years | 2 Years |

2.4.2. Geological Specialist

Persons who will provide geologic expertise must demonstrate that they possess the minimum qualifications of:

- A Bachelor of Arts degree in Geology; or a Bachelor of Science Geology, Geological Engineering, Geotechnical Engineering, or Mine Engineering; or an advanced degree, in Geology, Geological Engineering, Geotechnical Engineering, or Mine Engineering;
- Experience that demonstrates a thorough understanding of project analysis; and

- Successful completion of training on the use of available geologic modeling software or demonstrated proficiency in the use of the same or similar software.

Persons with certification as a Professional Geologist are preferable.

2.4.3. Mine Engineering Specialist

Persons who will provide mine engineering expertise must demonstrate that they possess the minimum qualifications of:

- A Bachelor of Science degree or an advanced degree in Mine Engineering, Geological Engineering, Geotechnical Engineering, or Civil Engineering;
- Experience that demonstrates a thorough knowledge of applicable MSHA regulations;
- Experience that demonstrates a thorough understanding of project analysis, equipment selection, mine design, production analysis and scheduling, labor planning, and mine cost analysis for applicable surface or underground mining methods; and
- Successful completion of training on the use of available geologic and mine simulation software or demonstrated proficiency in the use of the same or similar software.

Persons with certification as a Professional Engineer are preferable.

2.4.4. Economic and Market Specialist

Persons who will provide economic and market expertise must demonstrate that they possess the minimum qualifications of:

- A Bachelor of Science degree or an advanced degree in economics or business with emphasis on resource extraction, or a bachelor degree in another discipline with documented supplementary studies in economic and market analysis; and
- Successful completion of training on the use of available software for cash flow analysis and economic modelling or demonstrated proficiency in the use of the same or similar software.

2.4.5. Mineral Evaluation Analyst

Persons who will provide mineral evaluation expertise must demonstrate that they possess the minimum qualifications of:

3. A Bachelor of Science or advanced degree in economics, business, geology, or engineering with emphasis on mineral economics. At the discretion of the DSD, persons with supplemental training or experience in project analysis and a bachelor of science degree may serve in this position;
4. Experience valuing similar projects;
5. Successful completion of 120 classroom hours of courses in subjects related to mineral valuation and 15 hours related to standards of professional practice from a nationally recognized mineral economics or valuation, or valuation organization, college, or other recognized training program;
6. Successful completion of training on the use of available software or demonstrated proficiency in the use of the same or similar software.

2.5. Evidence of Evaluation Team Skills and Qualifications

All persons appointed to an ET must provide to the DSD, who is establishing the ET, a resume that provides a summary of all applicable education and work experience as evidence of their qualifications to serve on the ET. The resumes of all ET members will be included as an appendix to the valuation report.

2.6. Continuing Education

All ET members must also provide evidence in their resume that they have completed the equivalent of at least 40 hours of applicable advanced continuing education within the 5 years prior to being appointed to an ET. Training can be acquired through classroom or online training. Applicable course work must be related to any of the tasks required for completion of a coal evaluation. The applicable courses may be different depending on the specialty and needs of each individual. The DSD for Mineral Resources will determine if course work is applicable when establishing an ET. To this end, persons who may serve on an ET should consult with the DSD for Mineral Resources before enrollment in a class that they intend to apply to this continuing education requirement. A brief one paragraph summary must be provided for each class that describes why the class is applicable.

Chapter 3. Data Requirements

3.1. Introduction

The evaluation process requires that the ET search for, verify, and analyze information, which will form the foundation for estimating the pre-sale value of a coal tract. The type of information useful for this effort can include, but is not limited to, the following:

- Trends in supply and consumption demand for similar coal in the United States;
- Trends in international coal consumption markets for similar coal;
- Identification of potential consumption markets for the coal (metallurgical, steam, other);
- The applicants anticipated coal production from the tract being evaluated;
- Coal price forecasts for consumption of coal with similar characteristics;
- The actual sales value of similar developed or undeveloped coal properties (for example similar coal quality, mining method, stripping ratio, infrastructure capacity, etc.);
- Site-specific geologic and engineering data;
- The status of existing supporting infrastructure (railroad access, load out facilities, existing mine facilities, etc.);
- The forecast cost of capital equipment; and
- The anticipated annual operational costs.

The availability, type, and quality of the data and information helps to determine the evaluation method used to estimate the pre-sale fair market value of a prospective Federal coal lease.

3.2. General Data Requirements

The data requirements are organized into five general categories. A discussion of each data category is shown in Table 3.1.

Table 3.1
General Data Categories

| Category | Description |
|--|--|
| Environmental and Tract Configuration Data | Data used to establish the tract configuration and develop lease stipulations. Some of this data may be found in the documentation for the environmental analysis that was conducted under the National Environmental Policy Act (NEPA) to support the decision to offer the tract for leasing. The tract configuration defines the geographic scope of the valuation analysis and lease stipulations provide indicators of site specific costs. |
| Geologic Data | Data used to evaluate the physical and chemical characteristics of the coal to facilitate development and analysis of mine plans. The geologic data is also used for comparison to other coal properties to gauge if the tract being evaluated is similar to other coal properties. |

| Category | Description |
|--|--|
| Engineering and Operational Cost Data | Data used to develop mine plans, estimate mining costs, and to provide tract data that can be compared to other coal properties. Cost data will quantify the acquisition and operational costs required to procure and operate equipment and facilities required to mine and process the coal in the MU. |
| Economic and Domestic Coal Market Data | Data used to evaluate short and long term coal demand, evaluate expected coal prices and price trends, and to provide tract data that can be compared to other coal properties. |
| Export Coal Market Data | Data used to evaluate opportunities for the sale of coal from within the MU in international markets. Also includes expected international coal prices and price trends, and the existence of infrastructure necessary to transport the coal for exports. |

3.3. Environmental and Tract Configuration Data Requirements

To the greatest extent possible, the pre-sale FMV estimate must consider all potential environmental costs that would be imposed by numerous regulatory agencies as requirements to develop a mine. Environmental data that will be incorporated into the final tract configuration will be evaluated in the environmental analysis that is required by the National Environmental Policy Act and that supports the leasing decision. Data and other information that are applicable to the valuation of the prospective coal lease tract or lease modification configuration and that the ET must describe in the analysis documentation include:

- All potential environmental costs associated with the requirements imposed by numerous regulatory agencies to develop a mine, to the greatest extent possible;
- A description of how the tract and the prospective lease conform with the Resource Management Plan (RMP) or other land use plan;
- A discussion of alternative tract configurations considered;
- A discussion of the competitiveness of each alternative tract configuration and rationale for selection of the preferred tract configuration; and
- A discussion of special lease stipulations evaluated and the anticipated cost to conform each special stipulation.

3.4. Property Status Data Requirements

The property status data for each parcel within the prospective lease or lease modification include:

- A legal land description of the property that is consistent with the preferred alternative selected in environmental analysis that is conducted under NEPA;
- A summary of surface and mineral ownership;
- A discussion of the status of qualified surface owners for each tract;
- A discussion of potential obstacles to obtaining a mining permit;
- A description of the potential conflicts with other resource users or developers;
- A discussion of the future risk of finding parts of the prospective tract unsuitable for

mining; and

- A discussion of available transportation alternatives for moving coal to prospective markets.

3.5. Geologic Data Requirements

The geological data consists of geologic, geophysical, and geographic data for the coal property being evaluated and for prior comparable transaction properties. The geologic data of each property may indicate geologic conditions that may affect engineering considerations that influence mine development. The ET must document the sources of the data and include maps and descriptions of geologic sections, if available. The ET must describe and substantiate the methods it used for evaluating the geologic information. The ET must also discuss the stratigraphic continuity between the prospective lease and the mine or other leases.

The ET should gather relevant geologic data for the property and for properties for which prior sale transaction information is available. The purpose of these data is to provide the ET with sufficient information to either specify a mine plan for the property or to compare salient property characteristics between the property and prior public or private coal sale transactions.

Geologic data includes the geologic, geographic, geophysical, and geo-structural characteristics associated with the property. The purpose of collecting geologic data is to provide the geologic information needed for the ET's analysis of mine development and to provide the essential technical information to compare characteristics of the property being evaluated with characteristics of similar properties for which there are prior known transactions. The extent to which these data are collected depends upon:

- The availability of data;
- The geologic data standards for the State or region, if applicable;
- Previous or planned exploration activities (both pre and post-lease application);
- The available data already collected by the ET, State, district, or field office geologists and mine engineers; and
- The ability to provide adequate defensible rationale for assumptions inferred from limited data.

3.6. Mine Engineering and Operational Data Requirements

The ET should gather and assess mine engineering data for the property being evaluated and for comparable properties for which prior sale transaction information is available. These data provide the ET with sufficient information to either specify a mine plan for the subject property or to provide comparable salient property characteristics between the coal property being evaluated and prior public or private coal property transactions. The ET should gather and consider the following engineering information:

- Quality and physical properties of the coal, inter-burden, and overburden, as well as conditions that affect the ability to mine (e.g., special water or rock stability problems);
- Geometric characteristics of the tract, including areal extent, continuity, thickness, structure, depth of the deposit, and proximity to existing mine infrastructure; and
- Geographic characteristics of the tract, including location, topography, and surface conditions.

Mine engineering data consists of capital and operating cost data associated with property development. The mine engineering data provides the timeline for mine development, cost, and

production basis for determining the revenue potential of property development. Mine engineering data also includes essential technical information to compare characteristics of the property being evaluated with characteristics of similar comparable properties for which there are prior transactions. The amount of the data collected depends upon:

- The availability of data;
- Typical mine operating procedures in the vicinity of the subject property;
- Review of mine plan submitted by the applicant;
- Potential for alternative mining methods;
- The ET's collection of available data; and
- The need to provide an adequate rationale for assumptions inferred from limited data.

Cost data is used to evaluate the expenses of producing coal from the property or to develop an adjustment to comparable sale transactions to account for differences in property attributes. The required cost data include capital costs, operating and auxiliary cost elements that determine the economic characteristics of mine development. The cost data to be collected are defined by the mine plan developed for the property and when applicable, for the comparable property. The specific cost elements required by the evaluation process are summarized as follows:

- Capital cost elements, which include acquisition costs associated with preproduction activity, mine development, and production;
- Operating cost elements, including costs associated with labor, material, maintenance, fuel, and utilities; and
- Auxiliary cost elements, which include contingency, indirect, and fixed costs.

The engineering data must document technical data concerning the mine plan and costs. An outline of the engineering data likely to be useful is presented in Table 3.2.

The mine plan is used as the foundation in subsequent income approach analysis. The ET should consider all mine development scenarios that can reasonably be applied to the conditions at the site. Geologic, geo-structural, and geographic conditions at each site, as well as economic factors, can influence mine development. Each mine plan must be site-specific to account for all the geotechnical, geographic, and economic considerations relevant to each property. Generic mine plans should be avoided.

The mine engineering section of the valuation report documents the data that the ET considers in determining the mineability of the coal property in question. Also included in this section are the region specific cost data used to develop capital, operating, and other cost elements for property valuation. These data include regional salary structure, equipment prices, local tax structure, electricity prices, and other individual cost items that comprise the data base of costs for the evaluation process. The ET must explain any cost differences between mine costs for an adjoining mine and the costs projected for the lease or lease modification.

Table 3.2
Mine Engineering Data Reporting Requirements

| |
|---|
| Mine plan scenario(s): <ul style="list-style-type: none"> ● Develop possible mine plans; |
|---|

- Discuss company data provided for the lease application or lease modifications, including the ET’s valuation and recommendations;
- Describe the mine and air quality permit requirements;
- Describe potential conflicts between development of the coal property and development of other minerals on the tract;
- Discuss boundary restrictions (roads, water, etc.);
- Discuss engineering constraints (roof, floor conditions, etc.);
- Describe environmental constraints.

Mine Engineering:

- Describe the mining method(s);
- Present an equipment list that includes quantities and value;
- Discuss the engineering parameters (swell factors, available equipment, utilization, plant and equipment capacities, etc.);
- Discuss the labor requirements;
- Describe the financial data (this data could be proprietary or confidential);
 - Equipment costs;
 - Labor costs;
 - Other financial data.

Facility sites and improvements:

- Discuss loadout and storage capacities;
- Discuss transportation information;
- Describe the type of transportation;
- Discuss if a railroad spur or loop exists at or near the site;
- Describe any site access issues and problems (for example, transportation of coal by trucking to the nearest railroad loadout).

3.7. Economic and Domestic Coal Market Data Requirements

The economic data requirements fall into three categories as shown in Table 3.3.

**Table 3.3
Economic and Market Categories**

| Category | Requirement |
|--------------------------------------|---|
| General economic data | General economic data provide information from which trends in coal supply and demand are drawn. |
| Specific lease tract economic data | Specific lease tract economic data provide information concerning coal prices, market expectations, and other information specific to the lease tract being valued. |
| Lease-specific comparable Sales data | Lease-specific comparable sales data provide information concerning prior sales of similar coal properties. |

The economic data in the valuation report presents formal documentation of the data gathered by the ET's market study. The valuation report will contain at least the minimum economic data required to support the valuation. Raw data need not be included in a formal report; however these data should be referenced to maintain an auditable link to the data. Confidential, sensitive and proprietary information can be included if clearly labeled as "confidential, sensitive, or proprietary data." The minimum requirements of the economic data for the evaluation are shown in Table 3.4

3.7.1. General Economic Data

The purpose of obtaining general economic data is to develop quantitative and qualitative criteria for evaluating expected coal production activity. The market study and the supplementary data provide important information regarding the short- and long-term outlook of the coal market. This information establishes a basis for assessing potential interest in the lease property. Moreover, data on coal prices will assist in developing future price expectations of the coal type of the lease property. Coal price trends may be estimated from past data and from expected regional marginal mine cost and demand data.

Economic data are based on a market study prepared by the State Office, the ET, or support contractors. The market study establishes the foundation for assessing the short- and long-term outlook for regional coal demand that includes:

- Information concerning short- and long-term coal demand and prices;
- Short- and long-term regional mining costs;
- Prices of coal property leases;
- Regional supply and demand relationships; and
- Regional mine production, including capacity and production expectation.

The information contained in the market study may be supplemented with the following data, if available:

- Planned near and mid-term additions to the coal-fired capacity of regional utilities;
- Planned expansions and conversions of large industrial coal users; and
- Coal market information concerning transportation costs, past and new coal contract prices by coal quality, mining method, and customer.

3.7.2. Specific Lease Tract Economic Data

The ET will obtain economic data specific to the lease tract to be valued. The data to be collected are as follows:

- Potential markets for the lease tract coal;
- Potential competition;
- Expected market and timing of the sale of the coal and expected coal sale price;
- Likelihood (given timing) of lease tract development and production;
- The market value information for coal with similar quality characteristics; and
- Marketing characteristics of the associated mine, if any, with which the lease tract may be developed, including contract prices.

The ET should consider empirical sources of coal price-quality relationships for coal

characteristics (e.g., Btu content, sulfur, ash) so that quality adjustments can be made to expected coal prices. Several Federal, State, and private sources provide freight on board (FOB) mine price and cost, insurance, freight (CIF) delivered price data. The ET should obtain new contract and spot price data.

3.7.3. Lease-Specific Comparable Sales Data

The ET should try to obtain data from neighboring mines. These data should include alternative markets, transportation alternatives and associated costs, coal type and quality, contracted coal prices, mining method, and any other information that may be relevant to the valuation process. It is essential that the ET discuss likely contract prices and production costs with neighboring mine owners, who may be able to use the lease tract. Information from neighboring mine owners may provide realistic estimates of lease tract-specific economic data.

The ET should obtain information concerning prior public and private coal property market transactions. The ET should characterize these transactions by location, coal type and quality, geologic conditions, geographic conditions, mining conditions and costs, proximity to transportation, likely development date, probability of development, and other property characteristics that can be used to assess comparability to the proposed lease tract. The ET must fully determine the terms of the transaction, such as royalty rate and payment terms, especially if the transaction is a private sale, so that the ET may properly use the comparable sale in the report.

**Table 3.4
Economic Data Reporting Requirements**

| Economic Data | Minimum Requirements |
|---------------------------|---|
| General Economic Data | The evaluation report will contain an overview of the market activity including: <ul style="list-style-type: none"> ● Data and data sources used to assess the short-, intermediate-, and long-term market potential for the coal reserves; ● A summary of the detailed market study; ● A summary of additional information provided by other offices and collected by the ET; ● An assessment of coal demand and potential markets, local lease sale price and production trends, coal price trends and coal price-quality data for similar coals; and ● An evaluation of production and transportation capacities that may influence the value of the prospective lease or lease modification. |
| Lease Tract Economic Data | The evaluation report will contain the property specific economic data used either to evaluate comparable sales data or to estimate the revenue potential of the property being evaluated. The report should: <ul style="list-style-type: none"> ● Document data and data sources used to develop the data base of lease related information; ● Discuss the potential markets for the coal if leased and an evaluation of the timing and likelihood of the coal markets; ● Estimate the likely coal sale prices and compile the coal price- |

| | |
|---|--|
| | <p>quality data that will provide the analytical and empirical foundation for coal price-quality adjustments;</p> <ul style="list-style-type: none"> ● Include information concerning transportation access and costs, contract coal prices, and other data obtained from neighboring mine owners or other sources; and ● Include information on capacities, costs, and markets for competing mines. |
| <p>Lease-Specific Comparable Sales Data</p> | <p>This section of the valuation report documents the data and data sources used to develop candidate properties for comparable sales analysis and should include:</p> <ul style="list-style-type: none"> ● A description of the transaction, including the names of the buyer and seller, the transaction date, and the transaction terms; ● A legal land description of the property, including tract name, section, township, range, and meridian. ● A description of the characteristics of the property, including transportation networks; and ● A qualitative and quantitative description of factors affecting the transaction sale price, including marketing outlook at the time of the transaction, coal type and quality, and the status of an existing or potential mine. |

For completeness, each comparable sale’s geologic and mine engineering data (discussed in Sections 3.3 and 3.4) is cross referenced in this section.

3.8. Export Coal Market Data Requirements

Coal export data includes data or information concerning the historical and prospective international markets for coal that is similar to the coal within the MU being evaluated. Data and information of interest includes:

- The quantity of coal exports;
- The existence of a transportation and port-terminal network for current or future coal exports (e.g. railroad, road, waterways, port facilities);
- The shipping costs to deliver coal to port terminals;
- The shipping costs to deliver coal from the port terminal to the place of consumption;
- The extent of other coal producing nations participating in international coal markets;
- The competitiveness of the international coal markets; and
- The net value to the mine (the coal sale prices less deductions that are allowable under ONRR regulations for coal beneficiation and transportation) of coal exports.

To the greatest extent possible, the ET should obtain information and other data concerning;

- The quantity, quality, and value of any international coal sales from the MU within the previous five years;
- The capacity of the MU being evaluated to produce sufficient quality and quantity of coal to compete in international coal markets;
- The terms and conditions of established international coal sales agreements for the MU being evaluated; and
- The applicant’s plans to internationally market the coal from the MU.

The export data must discuss and justify data and conclusions concerning export market potential and historical export activity.

3.9. Data Sources

Table 3.5 lists some potential sources of data useful to the evaluation process. An annotated listing of data sources is included in the Bibliography.

Table 3.5
Potential Sources of Evaluation Information

| <u>Data Source</u> | <u>Data Type</u> |
|-------------------------------------|--|
| Department of the Interior | |
| Office of Natural Resources Revenue | Royalty management data. |
| Geological Survey | Coal resource data. |
| Office of Surface Mining | Mine-specific information. |
| Department of Energy | Current and historical data on reserves, production, and consumption; Economic forecasts, electric power industry data; Mine costing data. |
| Department of Commerce | Coal export data. |
| Department of Labor | Regional labor statistics, equipment price indexes. |
| Department of Transportation | Coal transportation data. |
| Interstate Commerce Commission | Coal transportation data. |
| State and Local Governments | Prior sales transactions, regional information. |
| Coal Property Buyer/Sellers | Comparable sales data. |
| National Laboratories | Forecasts and other coal related data. |
| Private Organizations and Services | Economic and cost data. |
| Private Producers and Consumers | Coal prices, markets, capacities. |
| Mine Owners | Cost, markets, capacities, mine plans, and contract prices of nearby mines. |

3.10. Data Standards

Data standards address the quality of data to be acquired for evaluation of a delineated coal tract. A data standard defines the information necessary to make coal leasing and mitigation decisions. Each standard serves as a starting point for determining whether sufficient data exists to lease coal. Data standards can be established for specific States or regions to best match data requirement to actual on the ground conditions. Data standards should be consistent with the standards used for development of the applicable Resource Management Plan. Data standards should be identified for geology, soils and reclamation, hydrology, wildlife, air, cultural resources, socioeconomics, vegetation and land use.

An evaluation must use the most reliable available data. If multiple data standards are available, the evaluation should adopt the standard that provides the most reliable data. The final

evaluation report must include a summary of all data standards that were used within the analysis.

3.11. Computational Models

The ET should use computational models only if it has adequate knowledge of the model's methods and limitations. The ET must defend its use of all computational model results through appropriate sensitivity analyses, probability analyses, or other applicable methods. Examples of computational models include geologic, cash flow, and Monte-Carlo models.

The assumptions, equations, constants, and parameters used within computational models are all data relative to the valuation analysis. The ET must describe all software used to calculate alternative environmental, geologic, engineering, or economic interpretations, including a summary and justification of all assumptions, equations, constants (such as coal density or inflation rates), methodologies, and parameters used.

Chapter 4. Methods and Models Used for Valuation

4.1. Introduction

The coal property evaluation process is a systematic approach to property valuation. It consists of defining data requirements, assembling the best available data, and applying an appropriate evaluation method.

The valuation procedure must be an unbiased estimate of the value of the coal lease tract based on the available data. A hierarchical approach for determining FMV is based on two common valuation methods, the comparable sales approach and the income approach.

In the comparable sales approach, the value of a property is estimated from prior sales of reasonably comparable properties. The basis for estimation is that the market would impute value to the subject property in the same manner that it determines value of comparable properties.

In the income approach, the value assigned to the property is derived from the present worth of future net income. When sufficient similar sales data are available, the comparable sales approach is preferred to other evaluation methods. Even if sufficiently similar sales are not available, the prior sales can be used to bracket the projected income approach.

In all cases, the ET must include in the valuation report a complete explanation that summarizes the reasons that it relied on one or both methods to estimate the pre-sale FMV for the subject property.

4.2. Hierarchical Evaluation of Coal Properties

A hierarchical system uses a sequential method to determine the pre-sale FMV estimate for Federal coal properties. One of the most important elements of this hierarchical valuation approach is that it recognizes that there are some methodologies and data sources that are superior to others. When using this hierarchical approach to estimate FMV, it is important that the analyst sequentially documents the methodologies attempted, and explains why each higher-ranked FMV methodology could not be used to estimate FMVs. Figure 4.1 provides a conception flow chart for the hierarchical method.

The best approach for determining FMV, when applicable, is when the analyst can use unadjusted comparable sales data. The use of the unadjusted comparable sales method is justified when a sale occurred recently and sale property parameters, such as physical characteristics of the coal, mine plan, location, and proximity to the markets are sufficiently similar (Refer to Section 4.5.2 for guidance on determining similarity).

In cases when no sufficiently similar sales are available, the adjusted comparable sales method can be used where the pre-sale FMV estimate is represented by quoted prices of sales from active markets that are adjusted for age, location, coal characteristics, or other features.

However, in some cases, there is not enough comparable sale information, or the information is not similar enough, for an analyst to construct a complete and well-documented valuation report

for the pre-sale FMV estimate using comparable sales. In the event that comparable sales data cannot be adjusted to yield a complete and well-documented valuation report for the pre-sale FMV estimate of the offered property, the analyst must document why the comparable sales method could not be used to estimate the pre-sale FMV. If the comparable sales approach cannot be used, the ET must consider the income approach.

The income approach is the most labor intensive evaluation method for pre-sale FMV estimate, and has the greatest uncertainty. The income approach requires the analyst to use judgment to construct a detailed, year-by-year revenue and cost estimate of a hypothetical coal mining operation inclusive of the recovery of all coal reserves contained in the offered property. It is important that the analyst fully documents and justifies all data sources, assumptions, and calculation methods. This methodology is discussed in more detail below.

Finally, the least preferred methodology for estimating FMV for coal properties is one that assigns value by using a minimum dollar amount that is based on regulatory minimum value. Regulations at 43 CFR 3422.1(c)(2) establish a minimum value that can be received by Treasury for a coal lease of \$100 per acre. The minimum regulatory value is only be used when other methods of estimating value yield results that are less than the equivalent of \$100 per acre. This information should never be used as a comparable sale for future evaluations.

4.3. Application of Evaluation Methods to Federal Coal Lease Tracts

The coal property being evaluated, with other adjoining Federal or non-Federal coal tracts that form a MU, will be classified as one of three tract types. The tract type determines the extent of analysis required. Refer to Section 1.5.4 for discussion of MUs. The three tract types are as follows:

Type 1 Tract.

A single tract that independently constitutes a MU for a new mining operation with a distinct, practical, and economic access. The tract contains sufficient reserves that can be developed and mined in an efficient, economic, and orderly manner with due regard for the conservation of coal resources and other resources.

Type 2 Tract.

A single tract that constitutes a portion of an MU for a new mine operation. The tract does not contain sufficient reserves or access to independently support a mining operation; however, the reserves can be used with other contiguous reserves to create an MU for a new mining operation.

Type 3 Tract.

A single tract that would provide an incremental addition to the recoverable reserves of an existing mine operation or MU. The tract does not contain sufficient reserves or access to independently support a mining operation; however, the reserves can be mined economically in conjunction with an existing mine(s) operation. In addition to lease-by-applications, this tract type includes lease modifications and bypass coal tracts.

Figure 4.1
Hierarchy for FMV Estimation for Offered Property

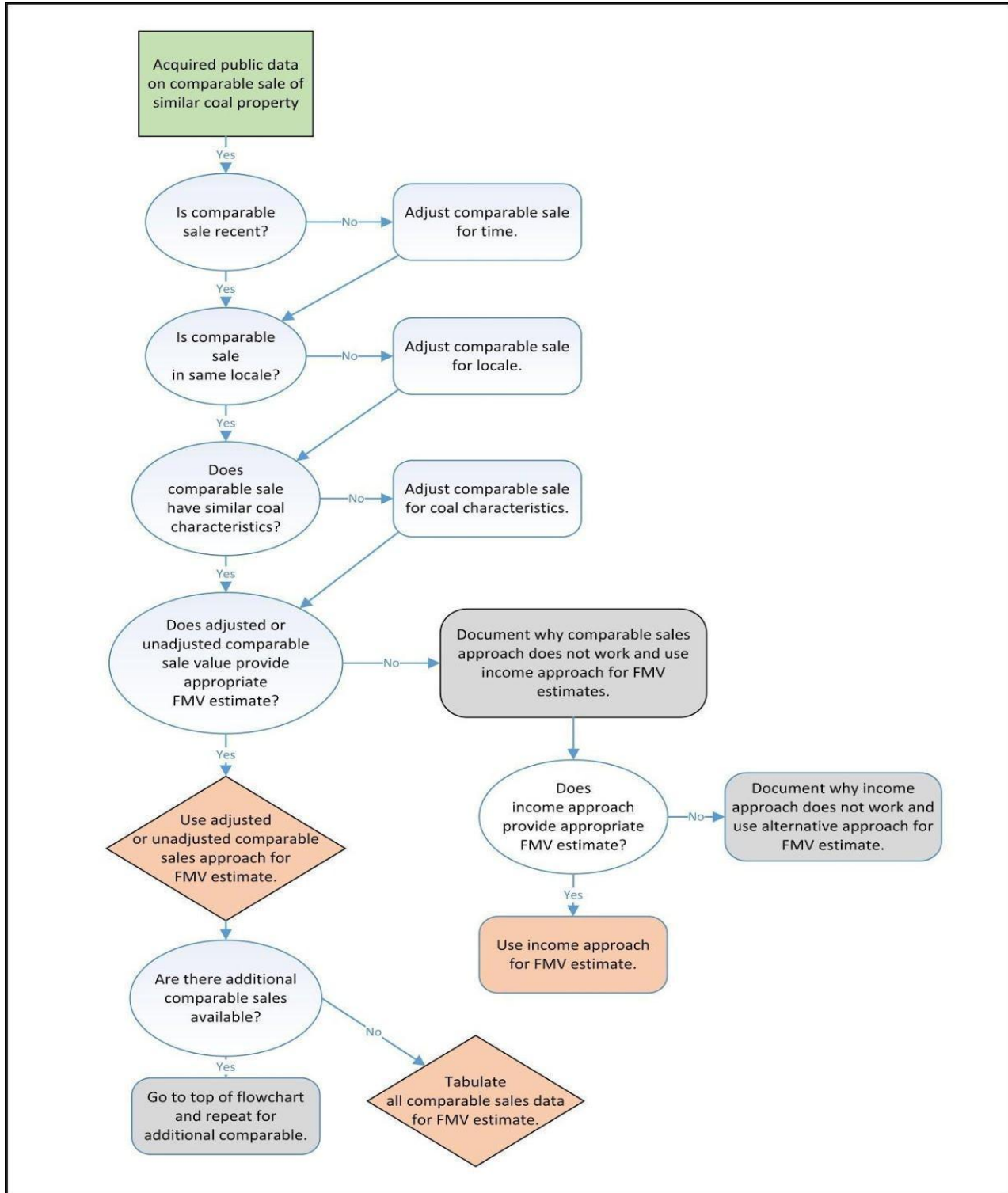

This section describes the application of the hierarchical approach to the estimation of FMV of each Federal coal lease tract type. First, the comparable sales approach is discussed. If the comparable sales approach cannot be implemented, the income approach should be used. In special cases, when neither comparable or income approaches would present a defensible FMV estimate, alternative methods could be used if adequately explained, documented, and justified.

4.3.1. Valuation of Type 1 Tracts

A Type 1 Federal coal lease tract is a tract that can be an MU for a new mine operation. To determine FMV of Type 1 tracts the hierarchy as described above should be followed. The analyst will start with comparable sales and then move to the income approach if needed.

The types of comparable sales that can be used to value Type 1 tracts include:

- Sale of an entire MU for a new mine operation;
- Sale of a portion of an MU for a new mine operation;
- Sale of a relatively large addition to existing mine reserves.

Following the procedures outlined in Section 4.3, the sales will be ranked, selected, and adjusted as necessary. Use the income approach to value Type 1 tracts when comparable sales data are unavailable. The income approach should be followed as discussed in Section 4.4.

4.3.2. Valuation of Type 2 Tracts

A Type 2 Federal coal lease tract is a tract that is a portion of an MU for a new mine operation. A Type 2 tract cannot be mined or accessed economically as an independent unit. Its value is derived from the value of the MU to which it is attached. To determine FMV of Type 2 tracts, the hierarchy as described above should be followed. The analyst will start with comparable sales and then move to the income approach if needed. Comparable sales that can be used to value Type 2 tracts include:

- Sale of an entire MU for a new mine operation.
- Sale of a portion of an MU for a new mine operation.

Following the procedures outlined in Section 4.3, the sales will be ranked, selected, and adjusted as necessary. Use the income approach to value Type 2 tracts when comparable sales data are unavailable. The income approach should be followed as discussed in Section 4.4. For Type 2 tracts, more than one MU may be possible for the Federal tract. The analyst elects the MU configuration that is most likely to be developed. If all MU configurations are equally likely to be developed, select the most profitable MU.

4.3.3. Valuation of Type 3 Tracts

A Type 3 Federal coal lease tract is a tract that is an incremental addition to an existing mining operation and that cannot be accessed and/or mined economically as an independent unit. Its value is based on its incremental value to the existing mining operation and not on its “stand-alone” value to the Federal government. To estimate FMV of Type 3 tracts, the hierarchy as described above should be followed. The analyst will start with comparable sales and then move to the income approach, if needed.

Comparable sales that can be used to value Type 3 tracts include the following:

- Sale of a Type 3 tract. The tract is an increment to an existing mine. It is important that the situation of the comparable tract with respect to the mine and its reserves be similar to the offered tract. If it is not, an incremental estimate by the income approach may be superior.
- Sale of a portion of an MU for a new mine operation (Type 2 tract).
- Sale of other types of tracts.

The use of a Type 2 tract comparable sale to estimate value of a Type 3 tract may be less reliable than the use of an appropriate prior sale of a Type 3 tract. The use of a similar Type 3 tract is preferred since valuation is based on its incremental value to the existing mine operation.

If the offered tract situation is unique with regard to the mine and its reserves, an incremental Type 3 estimate using the income approach may be superior. This is particularly true of bypass tracts. The income approach for Type 3 tracts is conducted in three steps:

- Step 1 – The analyst creates a discounted cash flow (DCF) for the existing mining operation and calculates the net present value (NPV).
- Step 2 – The analyst creates a second DCF analysis that represents the combination of the existing mining operation and the Type 3 tract being evaluated and the combined NPV calculated. The assumptions for each DCF must be consistent.
- Step 3 – The difference between NPVs calculated in Steps 1 and 2 is the contribution to the value due to the addition of Tract 3.

4.4. Building Evaluation Models

With the exception of the unadjusted comparable sales method, all the other evaluation methods require some form of mathematical modeling. For detailed description and examples of the models pertinent to certain methods, please refer to the appropriate section in this chapter. The general requirements for any analytical model are:

- **Documentation.**

The ET must clearly explain and document the process it followed in deciding on the modeling method and technique it used in the evaluation. Documentation of each modeling method or technique must include a description of the modeling process including:

 - **Calibration.**

The analyst must demonstrate and evaluate how well a model reflects observed data.
 - **Sensitivity Analysis.**

A sensitivity analysis quantifies the change in the pre-sale FMV estimate after a critical variable is changed by a known amount, thus measuring the sensitivity of the pre-sale FMV estimate to a known change in critical input variable. The analyst should use sensitivity analysis to evaluate contributions from model variables, and also to make sure that these relative contributions reflect trends observed in and supported by the data.
 - **Error analysis.**

Statistical analysis should be performed for the error analysis. The analyst should discuss sources of errors and potential impact(s) of the errors on the pre-sale FMV estimate.
- **Validity.**

The ET must clearly describe input and output parameters in the report. Data selection for the input parameters must follow the guidelines presented in Chapter 3.

4.5. Comparable Sales

All evaluations should start with comparing sales from the market to the subject property. The comparable sales method of estimating the pre-sale FMV compares the aspects of the property being evaluated to aspects of comparable properties previously sold. It is extremely important to document the rationale for this approach.

When using the comparable sales approach:

- The sales prices must be determined in a competitive market;
- The sales prices must result from transactions between knowledgeable buyers and sellers;
- Neither the buyer nor the seller were under undue pressure to buy or sell;
- The environmental permitting risks for each property must be similar; and
- The direct financial factors (factors or costs that are proportional to the amount of coal produced) and indirect financial factors (factors or costs that are constant relative to the amount of coal produced) must be able to be quantified for adjustment.

For Federal coal properties, the procedure for applying the comparable sales approach is as follows:

- **Data Collection.**
Extensively research sources of comparable sales transactions to obtain information about transactions of similar properties. Data requirements for comparable sales are discussed in Chapter 3.
- **Eligibility.**
Identify potential prior transactions, and verify the accuracy and completeness of available information. This includes geology, coal quality, market position, transportation, workforce, and others. Federal coal lease sales where the FMV accepted for the offered parcel was equal to the regulatory minimum acceptable bid cannot be used as a comparable sale in a future comparable sales analysis (Refer to Section 4.5).
- **Rating.**
Use a ranking process to select comparable sales that are most similar to the offered coal property. Table 4.1 offers one example of how to rank multiple properties (Refer to Section 4.5.1).
- **Selectability.**
Review the property attributes for similarity to the property being evaluated to determine if the data can be used without adjustment or if an adjustment is required. If an adjustment is required, determine whether sufficient information is available to adjust for differences in property attributes and business factors. Property attributes and business factors that affect coal tract value include, but not limited to, heating potential (Btu per pound), sulfur content, sodium content, stripping ratio, timing (when coal production from the tract begins), duration (how long coal is produced from the tract), tract size (acres), etc. The appropriate attributes should be considered for adjustments (Refer to Section 4.5.5).
- **Reconciliation.**
Reconciliation is the final step for the comparable sales approach. Reconcile multiple estimates of value into a single indication of value (pre-sale FMV estimate) and

document the reasoning. Justification must be given to any methodologies and data chosen for the reconciliation.

Previous sales do not have to be identical in order to be comparable as long as there is a technically-based judgment that they are reasonably similar, or technically-based adjustments can be made to account for any differences.

Variations in property attributes between the property being valued and the comparable properties can be accounted for, if necessary, through a documented monetary adjustment to each comparable property's value. For example, if a lease tract being evaluated has coal of higher energy content (Btu) than a comparable sale, then the price paid for the comparable sale would be adjusted upwards to account for the increased energy content of the tract be valued.

4.5.1. Eligible Comparable Sale Transactions

The criteria will be used to determine tracts eligible for comparable sale analysis are shown in Figure 4.2 and described as follows:

- **Transaction Identification.**
Coal property sale transactions within the coal region (as defined at 43 CFR 3400.5) that include the tract being valued must be evaluated for eligibility. The identification of transactions must be based on an extensive search. Evidence of the search must be documented, including details about where property records were obtained or examined, and how supporting information was obtained. Potential sources of information include Federal and State coal lease sales, Indian coal sales, and private sales.
- **Transaction Terms and Price.**
All the terms and price of the transaction must be verified with the buyer and seller and documented.
- **Not-Obligated Buyer and Seller.**
The transaction should be examined to ensure that there is no indication of undue stimulus to buy or sell. If possible and if both the buyer and the seller are willing, they should be contacted to verify motivation and nature of the transaction.
- **Knowledgeable Buyer and Seller.**
Evidence should be presented demonstrating that the buyer and seller are knowledgeable and competent and the transaction was intended to result in the most financially favorable market price for each.

Figure 4.2
Diagram for Determining Eligible Comparable Sales Transactions

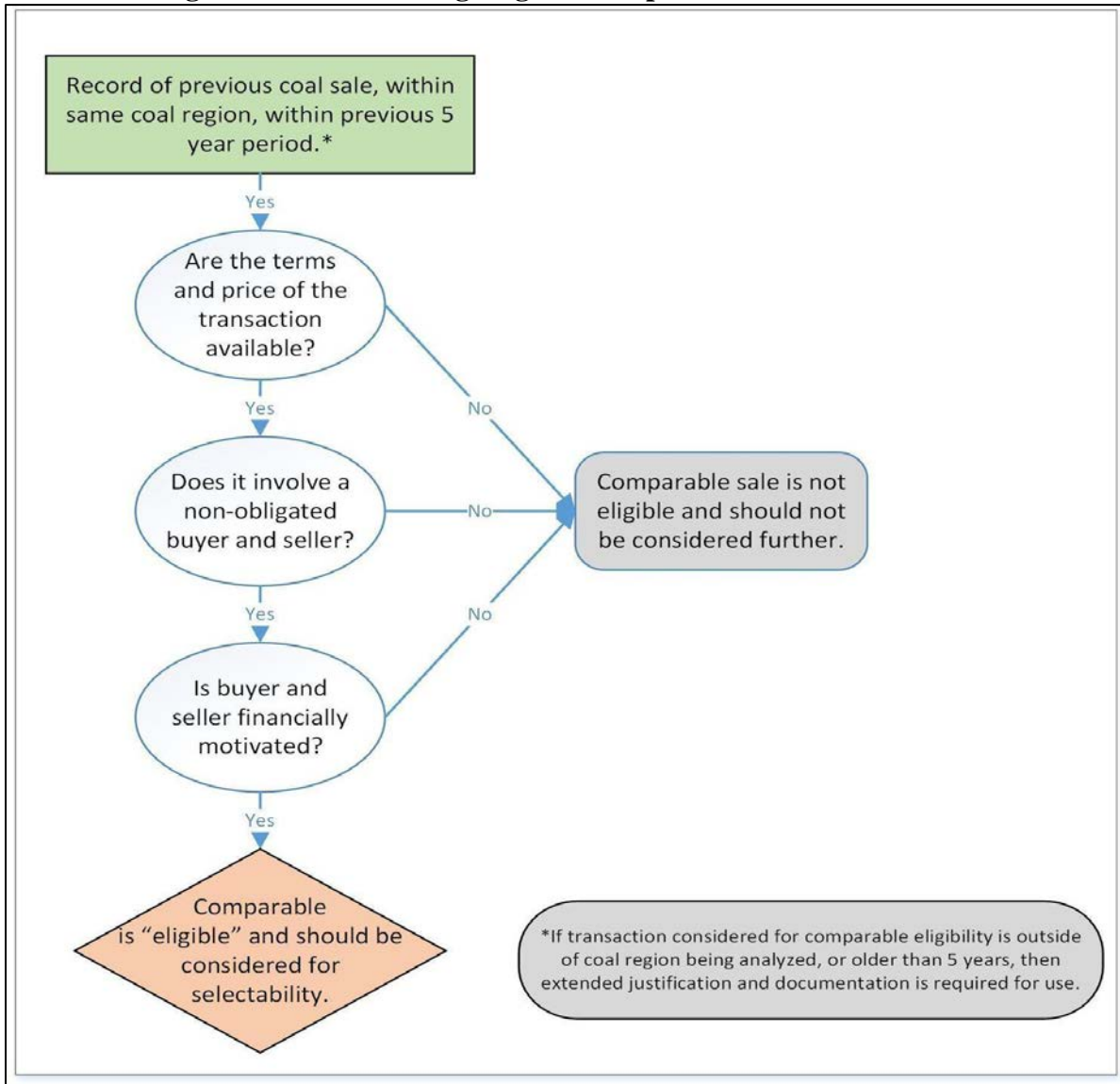

4.5.2. Ranking Eligible Comparable Sales

When there are many eligible transactions, some transactions will be more comparable than others. Only the most comparable transactions need to be considered for selection. The analyst must focus their attention to transactions that are most similar to the offered tract. A ranking procedure must be implemented to identify those most comparable transactions.

There are many criteria to consider when ranking a prior transaction for comparability. The primary criteria are:

- **Time of Sale**
 The most recent transactions are preferred.

- **Market Conditions.**
Market conditions may still have changed significantly between the transaction date and the evaluation date.
- **Terms of Sale.**
Value is normally stated in terms of cash, or its equivalent, payable at the time of sale. The terms of sale of the property being evaluated can differ from the terms of the eligible transaction. The differences must be evaluated.
- **Engineering and Geologic Characteristics.**
For example, stripping ratio, seam thickness, depth to deposit, seam continuity, etc., can influence the value and marketability of a prospective tract, and differences with the comparable transactions must be evaluated.
- **Coal Characteristics.**
Differences in Btu content, sulfur content, ash and other coal quality characteristics will affect the value and marketability of a coal tract and must be evaluated.
- **Production Scheduling.**
Coal value is affected by how soon the tract is anticipated to achieve full production, the risks of environmental permitting delays, the rate of production, and the differences must be evaluated.
- **Access to Property and Transportation.**
Access to the property and proximity to transportation and markets must be evaluated.
- **Other Factors.**
Other factors (such as buyer control of adjoining property or have established coal sales contract that can be fulfilled with coal from the property being evaluated) that may cause value differences between the comparable tracts and the tract being evaluated must be identified, described, and evaluated.

One procedural example for ranking the eligible comparable sales is shown in Table 4.1. Numeric values associated with the proposed tract can be quantitatively compared to that of the selected comparable sales. The analyst must exercise professional judgment when comparing non-quantitative factors. The decision and reasoning of the analyst must be thoroughly documented and justified.

As a result of the ranking process, comparable sales most similar to the offered property are identified. The matrix should be used to compare numerical values between two or more comparable sales.

4.5.3. Special Considerations

Certain transactions are not normally considered acceptable evidence of value and must not be used in evaluations; others may be used if better data are unavailable. If a transaction is used, the analyst must explain the basis for selection, and present clear evidence as to why the transaction represents a useful indicator of value.

Table 4.1
Example: Ranking Process for Selection of Comparable Sales

| SIMILARITY MATRIX | | | | | | | | Effect on Cash Flow |
|----------------------------|-------------------|---------------------|-------------------|---------------------|-------------------|---------------------|-------------------|---------------------|
| Underground Coal - xyz LBA | | | | | | | | |
| | <u>LBA xyz</u> | <u>Comparable A</u> | Similarity Factor | <u>Comparable B</u> | Similarity Factor | <u>Comparable C</u> | Similarity Factor | |
| Geologic | | | | | | | | |
| Seam Thickness (ft.) | 10 | 8 | 0.80 | 12 | 0.83 | 11 | 0.91 | |
| Btu | 11,600 | 11,500 | 0.99 | 12,800 | 0.91 | 11,300 | 0.97 | High |
| % Sulfur Content | 0.27 | 0.25 | 0.93 | 0.30 | 0.90 | 0.15 | 0.56 | High |
| % Ash Content | 4.50 | 3.00 | 0.67 | 4.40 | 0.98 | 5.30 | 0.85 | High |
| % Sodium Content | 1.86 | 1.34 | 0.72 | 1.23 | 0.66 | 1.67 | 0.90 | High |
| Depth (ft.) | 2,200 | 2,300 | 0.96 | 2000 | 0.91 | 1,500 | 0.68 | Low |
| Market | | | | | | | | |
| % Export | 20% | 10% | 0.50 | 25% | 0.80 | 20% | 1.00 | Low |
| % Electrical | 95% | 95% | 1.00 | 75% | 0.79 | 80% | 0.84 | Medium |
| % Industrial | 5% | 5% | 1.00 | 25% | 0.20 | 20% | 0.25 | High |
| Mining | | | | | | | | |
| Long wall | 75% | 80% | 0.94 | 0% | 0.00 | 70% | 0.93 | High |
| Continuous Miner | 25% | 20% | 0.80 | 100% | 0.25 | 30% | 0.83 | High |
| | | | A | | B | | C | |
| | Similarity | 85% | | 66% | | 65% | | |
| Other factors | | | | | | | | |
| Gas | Moderate | Moderate | | Low | | Very High | | Medium |
| Faulting | Moderate | Extensive | | None | | Moderate | | Medium |

Transactions that cannot be used as comparable sales include:

- Sales between interrelated companies, unless it can be shown that the sale represents an arm’s-length transaction.
- Sales by government organizations that may have had objectives other than receipt of market value (e.g., industrial development) should not be used, unless it can be ascertained that competition among bidders in these sales was itself sufficient to ensure receipt of FMV.
- Prior government sales that accepted regulatory minimum bids should never be used as a comparable sale.

4.5.4. Selectable Comparable Sales

The selected comparable sale transactions can be used to estimate the value of an offered coal property through three alternative approaches: unadjusted transactions; adjusted transactions; and regression analysis. Regression analysis must be supported by a sufficient number of data points, or sample size, to adequately defend results. Refer to Figure 4.3.

- **Unadjusted.**
A transaction is an unadjusted transaction when it appears that there is sufficient commonality of characteristics between the comparable transaction and the offered property. Documentation must be provided by the analyst that the unadjusted transaction is a reasonable estimate of offered lease tract’s value.
- **Adjusted.**

If one or more characteristic of a previous transaction differ enough to significantly affect the value of the offered property, then the analyst must adjust the comparable sale transaction to account for the differences. Documentation and justification of the analyst's adjustment factor(s) is required.

- **Regression Analysis.**

If the analyst shows that neither unadjusted nor adjusted transactions can be used to yield a defensible pre-sale FMV estimate, a regression analysis can be used. Regression analysis may establish statistically significant relationship between FMV and various parameters, such as coal characteristics, recoverable coal reserves, distance to the available transportation point, etc.

4.5.5. Unadjusted Transactions

Unadjusted transaction prices can be used as comparable sales when the characteristics (Refer to Section 4.5.1) between the comparable transaction and the offered property are sufficiently similar that an adjustment to the transaction price is not warranted. The analyst must provide documentation to justify the choice of this method.

4.5.6. Adjusted Transactions

A selected comparable sales transaction should be adjusted if it is necessary to account for differences between the characteristics of the comparable property and the offered property. There are several methods for adjusting comparable sale transaction values to estimate the value of the offered tract. Several common adjustment methods are provided in the following discussion, but the ET may use other methods as long as it appropriately justifies and documents use of that method in the evaluation report.

For all adjustment methods, the ET must clearly establish and document in the evaluation report the relationship between the characteristic(s) being adjusted and the change in value of the comparable sale(s).

4.5.6.1. Contract Method

The contracts for the sale of severed coal may contain clauses for penalty or premium adjustments to the contracted transaction price that are agreed to between buyers and sellers in the actual market. When appropriate, these contractual adjustments in value can provide a simple and reasonable way to adjust comparable sales transactions for coal quality or other characteristics.

Figure 4.3
Flowchart of Selectable Comparison Use and Adjustment

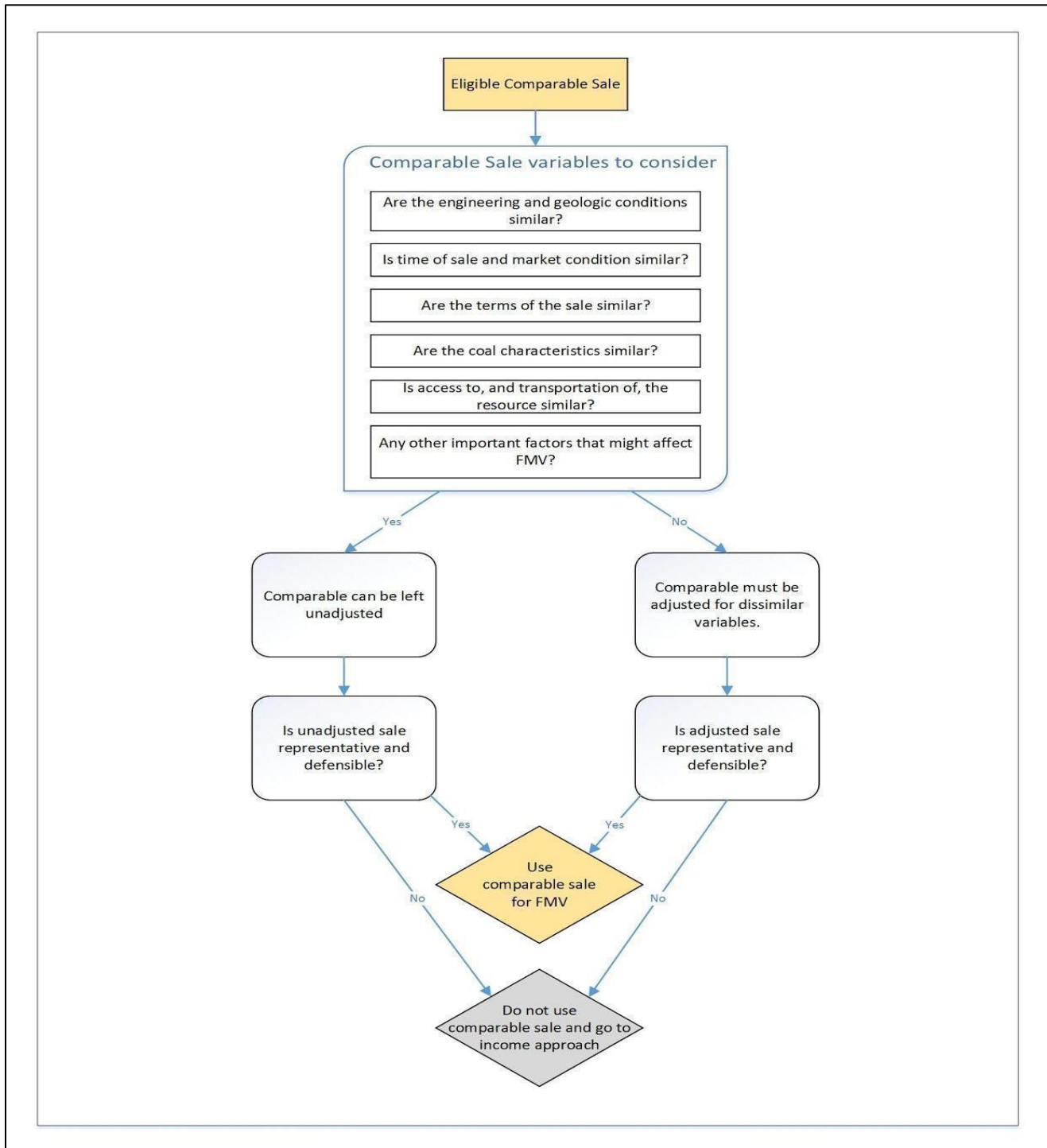

Coal sales contracts commonly contain specifications for “typical” as-received quality specifications for Btu, ash, sulfur, moisture, or other characteristics (Figure 4.4). Many contracts also specify a rejection level or an acceptable range for many of the coal characteristics. If the

coal is within the range of acceptable quality that are established in the sales contract, an upward or downward adjustment can be made to the coal purchase price based on whether the as-received quality exceeds or falls short of the average coal quality established in the contract.

Figure 4.4
Example Coal Sales Contract Method

The “sales contract” based technique is used in many current and recent past contracts to reduce or increase the contract price by multiplying the contract price by the following ratio

$$\frac{\text{(As Received Btu/lb. – Typical Btu/lb.)}}{\text{Typical Btu/lb.}}$$

If an offered coal tract has a typical heating value of 10,000 BTU/lb., and the comparable sale transaction was based on coal averaging 10,500 BTU/lb, the adjustment ratio would yield

$$\frac{\text{(10,500 Btu/lb. – 10,000 Btu/lb.)}}{\text{10,000 Btu/lb.}}$$

Or **5 percent.**

The sales price of the comparable property is then decreased by 5 percent to reflect the buyer's willingness to pay a premium of 5 percent for the higher quality coal and respectively normalize the price of the offered tract to reflect the relative drop in quality.

4.5.6.2. Regression Analysis

Regression analysis is an alternative tool for comparable sales analysis. A regression analysis requires a minimum amount of data that may not be available for most coal properties. As a stand-alone method for estimating value, multiple linear regression (MLR) should be used with caution due to its dependency on a substantial number of data points for accurate estimation. However, when used properly, MLR can be very useful for adjustment of comparable sales.

MLR should be used only when the following conditions are met:

- There is a representative sample of quality data available (Refer to Chapter 3 for data requirements).
- A visual examination of the scatter plot indicates linear relationship that might exist between the variables.
- A linear relationship between variables does not contradict well-established patterns in the industry data (for example, higher BTU will lead to higher price).

The estimation procedure using MLR is as follows:

- Collect data concerning lease tract value (price) from past sales and each attribute contributing to value.
- Analyze the data to determine if the database is sufficient to provide statistically significant results.
- Apply multiple regression procedures to determine a statistical expression (regression

equation) of lease tract value in terms of the property attributes.

- Estimate value by applying the attributes of the Federal coal property being valued to the regression equation.
- Validate the results with the help of statistical methods (compute cross-correlation, perform sensitivity analysis to determine the most important contributing variable, perform the statistical *f* test, etc.).
- Document all assumptions, data, calculations, verification, and conclusions.

Appendix A provides additional directions to assure consistent MLR analysis.

4.5.7. Reconciliation of Indicated Values

The final step in the comparable sales approach is the reconciliation of estimated values into a single indication of value for the subject property. In determining a single value from a set of estimated values (both unadjusted or adjusted value indications), the analyst may give more weight to specific estimated values if the properties are more representative of the sale tract.

For example, more recent transactions may be preferred to older transactions, or a particular transaction may differ in only one attribute. Regardless of the method of reconciliation used, its purpose is to provide a single estimate of the value of a prospective lease tract. The analyst, therefore, must provide a clear rationale concerning how the indicated values were reconciled to a single indication of value.

A single estimate of the value of a lease tract may be selected from alternative value indications if, in the analyst's judgment, it is the only meaningful indication of value for the tract. Basing an estimate of value on a single observation is undesirable unless it can be shown that the observation is highly informative and clearly superior to others.

4.6. Income Approach

In the absence of similar comparable sales data or the inability to reconcile previous transactions, the risk weighted income approach, which measures the value of a property's earning potential, is a viable alternative to the comparable sales approach.

The value imputed to a Federal coal property (and thus the pre-sale FMV estimate) is determined by quantifying net future benefits. The income approach reduces the total net lifetime amount of these benefits into a single indication of value by converting future monetary benefits to present value at a specified discount rate. The process of converting future benefits to present value is called discounting.

The income approach estimates net present value (NPV) of a Federal coal property by discounting projected annual cash flows to the present. The projected annual cash flow is determined from projected annual revenue, capital and operating costs, taxes, and other expenses. The data required to implement the approach are based on the economic and engineering data discussed in Chapter 3. This information is used to project annual revenue and cost estimates for property development, production, and reclamation.

Although methods are presented in this section to account for uncertainty, as always, it is important that the ET document and justify all assumptions and input values before accepting the

result of the income approach as a reasonable estimate of a tract's pre-sale FMV.

4.6.1. Overview of the Income Approach

The general procedure for applying the income approach is as follows (Figure 4.5):

- Assemble data, such as operating and capital costs, and the prospective market value of the coal;
- Develop a mine plan based on geologic information that will achieve MER;
- Develop coal production data that identifies on an annual basis the quantities of labor, operating costs, and capital required for production of a defined quantity of coal;
- Combine and integrate the data into the cash flow model; and
- Perform the discounted cash flow analysis.

4.6.2. Mine Plan Selection

The analyst is required to assemble a mine plan that should represent the standard industry operating practices for achieving MER of the coal resource on the tract. For LBAs, the mine plan should be independent from plans submitted by the applicant, and only determined by the tract type, tract-specific characteristics, costs, and market. Note that while a mine plan can be developed independently of any prior approved mine plan from the applicant, the mine plan for a Type 3 tract may also need to be combined and reconciled with an established mine plan of an adjoining property. The analyst must explain the mine plan assumptions and process.

Information for developing alternative mine plans for the offered property may be included along with the geologic or engineering information for the tract in the evaluation report. Documents prepared under the National Environmental Policy Act and [for or by] the Mine Safety and Health Administration related to conditions for the tract might also contain pertinent information.

A mine plan may not be necessary for small tracts next to an existing mine (i.e. small lease modifications, bypass coal, or other non-competitive coal sales may fall into this category). However, in these cases, the mine plan need only show how the Federal tract will be mined so that prorated capital costs, operating costs, and contract coal prices can be applied correctly in the valuation process.

4.6.3. Determining Revenues

The schedule of projected annual coal production developed from the mine plan should be combined with estimated or known coal price information to determine the expected revenue profile associated with the mining operation.

In addition to documenting the predicted domestic market for the coal resources of the property, the market evaluation must include estimates of the amount and price of coal expected to be exported. Analysts must consider international markets and the netback price of coal the mine would most likely receive for this exported tonnage. Projected coal prices and volumes should be estimated based on available market research, including BLM subscribed coal market

**Figure 4.5
Income Approach Procedure**

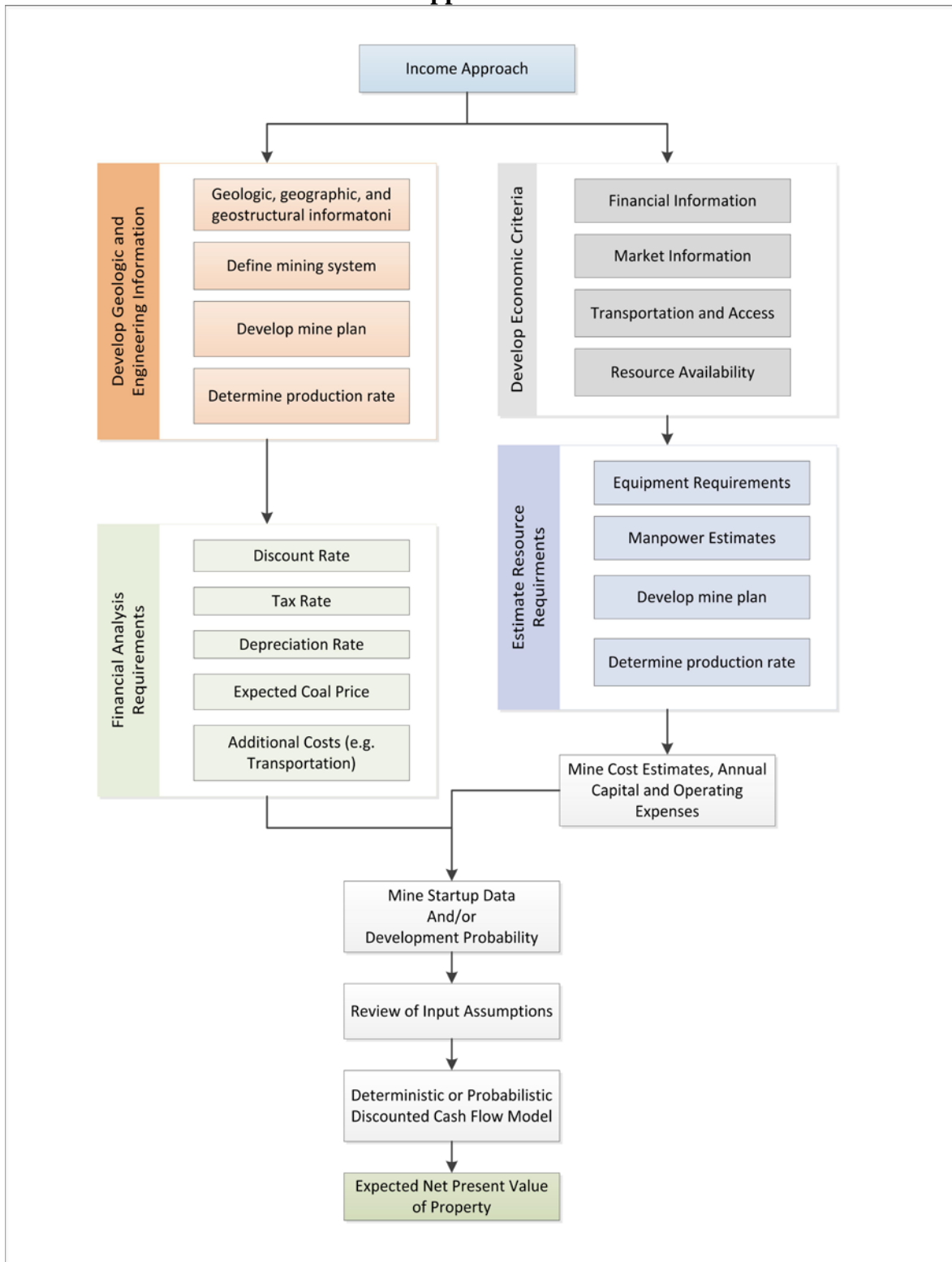

services, and this should be reconciled with the projected mine plan production.

4.6.4. Determining Mining Costs

The mining costs developed for the property include capital, operating, taxes, and corporate overhead costs associated with the mining operation. Capital costs and operating expenses are estimated based on projected annual production requirements for individual cost elements. Table 4.2 lists some of the cost data sources.

4.6.5. Cost Elements

A cost element is a logical grouping of associated costs. For example, all cost associated with labor (wages, safety, social security payments, health benefits, retirement benefits, etc.) would be grouped in a cost element labeled “labor.” Similarly, there can be cost elements for coal production, overburden removal, or any other logical grouping of costs.

4.6.5.1. Capital Cost Elements

Capital costs are associated with the acquisition of property or equipment and the value can be either depreciated or depleted under the tax laws. Capital cost elements include expenditures for services, construction, and equipment acquisition associated with capital expenditures for pre-production activity, mine development, and capital replacements for the proposed tract. Capital costs for the purposes of the income approach do not include costs associated with activities that occurred prior to the issuance of the lease or lease modification, but do include cost recovery expenditures (including NEPA) and BLM required exploration. The following capital cost elements should be considered by the analyst:

- Pre-mining Studies
- Site Preparation and Surface Facilities
- Mine Equipment
- Preproduction Development
- Indirect, Administrative, Contingency, and Working Capital

4.6.6. Discount Rates

The Department of the Interior currently uses a 10 percent real (adjusted for inflation), post-tax rate of return as the discount rate for coal property evaluation. This rate is based on the 10 percent real, after-tax rate that is required by the Financial Accounting Standards Board (F.A.S.B.) for valuing oil and gas reserves for the SEC (F.A.S.B., Topic 932, No. 2010-03, January, 2010). This value should be checked against actual economic conditions and for consistency with actual industry values prior to every analysis. The BLM may use a different value from another source; however this must be justified with well-reasoned documentation in the analysis.

Where the other inputs are stated in nominal terms, the discount rate should be a nominal rate. To convert the 10 percent real rate into a nominal rate, consult the current Office of Management and Budget Circular A-94, Appendix A to identify the appropriate inflation adjustment.

4.6.7. Discounted Cash Flow Analysis and Taxes

Federal coal lease tract value is estimated as the NPV of the projected annual after-tax cash flow of the modeled mining operation. Annual after-tax cash flow is determined from the annual cash income:

$$[\text{annual revenue} - \text{annual costs and taxes}] = \text{annual cash income}$$

Both the severance and income taxes must be deducted. Decisions concerning the handling of deductions to determine taxable income are important considerations to the estimation process. Allowable tax deductions are subtracted from gross income to determine taxable income. Deductions include severance taxes, royalties, operating and other expensed items, depreciation, and depletion.

Income taxes are calculated as a percentage of this taxable income. To derive annual cash flow, annual gross revenues in each year are reduced by cost outlays, including taxes. Tax calculations, such as proper use of depreciation, depletion, and amortization, for a DCF analysis, are fully explained in Stermole and Stermole, 2012, *Economic Evaluation and Investment Decision Methods*.

The application of the income approach using the DCF analysis to estimate value of a Federal coal property is illustrated in Figure 4.6.

4.7. Incorporating Uncertainty in the Valuation Process

Statistical methods should be an integral part of each evaluation to account for uncertainty and to establish confidence in the resulting estimate of value. A number of analytical techniques are available to evaluate the uncertainty. Any use of the techniques listed below must be clearly defined and defended in the analysis report. This section discusses three of these techniques:

- **Sensitivity Analysis.**
Statistical analysis of the relative contributions of parameters (geological, transportation, physical characteristics, etc.) to the valuation.
- **Probability Weighted Scenarios.**
A procedure by which the likelihood of expected outcomes are combined to yield an expected value. This can be illustrated with probability or decision trees¹ or other techniques.
- **Monte Carlo DCF Analysis.**
A probabilistic form of sensitivity analysis, in which the variation of input parameters are systematically incorporated in the DCF analysis to yield an expected (most probable) value.

4.7.1. Sensitivity Analysis

The analyst should apply sensitivity analysis to:

- Develop and demonstrate a better understanding of input and output variables; and
- Check the model for errors.

Numerous methods can be used for the sensitivity analysis. For example, if the analyst is interested in analyzing the relationship between Btu and price, the following methods can be used:

¹ <http://www.statisticshowto.com/how-to-use-a-probability-tree-for-probability-questions/>

¹ <http://vserver1.cscs.lsa.umich.edu/~spage/ONLINECOURSE/R4Decision.pdf>

- Scatter plots to visualize dependencies and relationships between the variables;
- Regression analysis to demonstrate mathematical relationships between variables; or

Figure 4.6
Discounted Cash Flow Analysis (DCF)

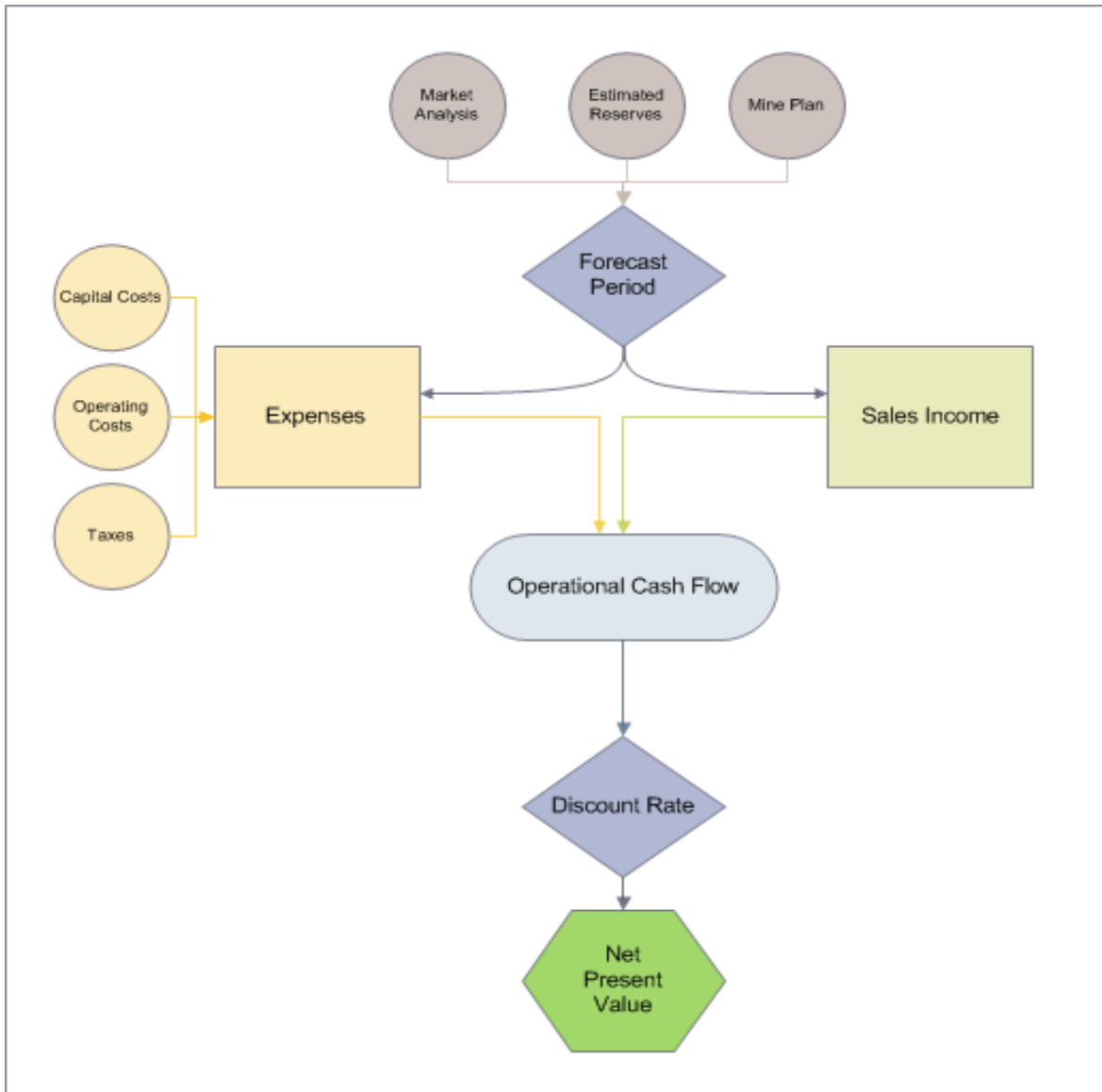

- Variance-based techniques to prove the statistical significance of the results.

The choice of method to use is dependent on the nature of the model. The analyst must justify the choice of the method and document the results of the sensitivity analysis.

4.7.2. Probability Weighted Scenario

Uncertainty is an important factor in the valuation procedure, such as an income approach, since it is impossible to obtain perfect information for all the DCF inputs, some of which depend on

future events. Uncertainty can be included in the valuation procedure by using probabilistic methods.

The most direct probabilistic method is to calculate the results of several alternative scenarios and to combine them by assigning a probability estimate of occurrence to each scenario. These probability estimates along with chosen scenarios must be justified and documented. Sensitivity analysis is highly advisable when choosing scenarios because it identifies factors that have the greatest impact on the FMV.

4.7.2.1. Decision Tree Analysis

A probabilistic method that is often used is the decision tree analysis, which is a graphical representation of a sequence of events and likely outcomes. The decision tree analysis is very useful when phases of risk and responses to outcomes can be easily identified. The following general steps constitute development of the decision tree:

- Identifying the phases carrying certain risks (for example tightening of EPA regulations);
- Calculating probabilities of the outcomes;
- Defining decision points;
- Computing NPVs at the end nodes; and
- Computing of the expected values by working backwards through the tree.

Figure 4.7. shows an example of the simplified decision tree. In this case, three risk factors are identified: 1) demand; 2) estimated reserves; and 3) anticipated Btu content.

The analyst should be cautious when assigning probabilities for each event, and provide justification based on market research and economic projections.

4.7.3. Monte Carlo DCF Analysis

Another probabilistic method is the application of the Monte Carlo simulation technique to the DCF method. This requires the development of probability distributions for the input variables. Insufficient data can limit the precise development of probability distributions; however, assumed distributions (normal, triangular, uniform, etc.) and variances (+ 25 percent, \pm 50 percent, etc.) may be used based on an evaluation of the data. Repeated application of the DCF method using Monte Carlo simulation generates an NPV distribution from which a single-weighted average (the expected NPV) can be determined.

The variances selected for the Monte Carlo simulation are especially important. For example, larger variances may raise values of the average case properties significantly because there is a greater probability to select variables that can lead to increased value. Care needs to be taken to limit losses on negative runs to actual loss due to non-development. For any simulation, the analyst must justify the distribution method, variances used, and the results.

Figure 4.7
Decision Tree Example

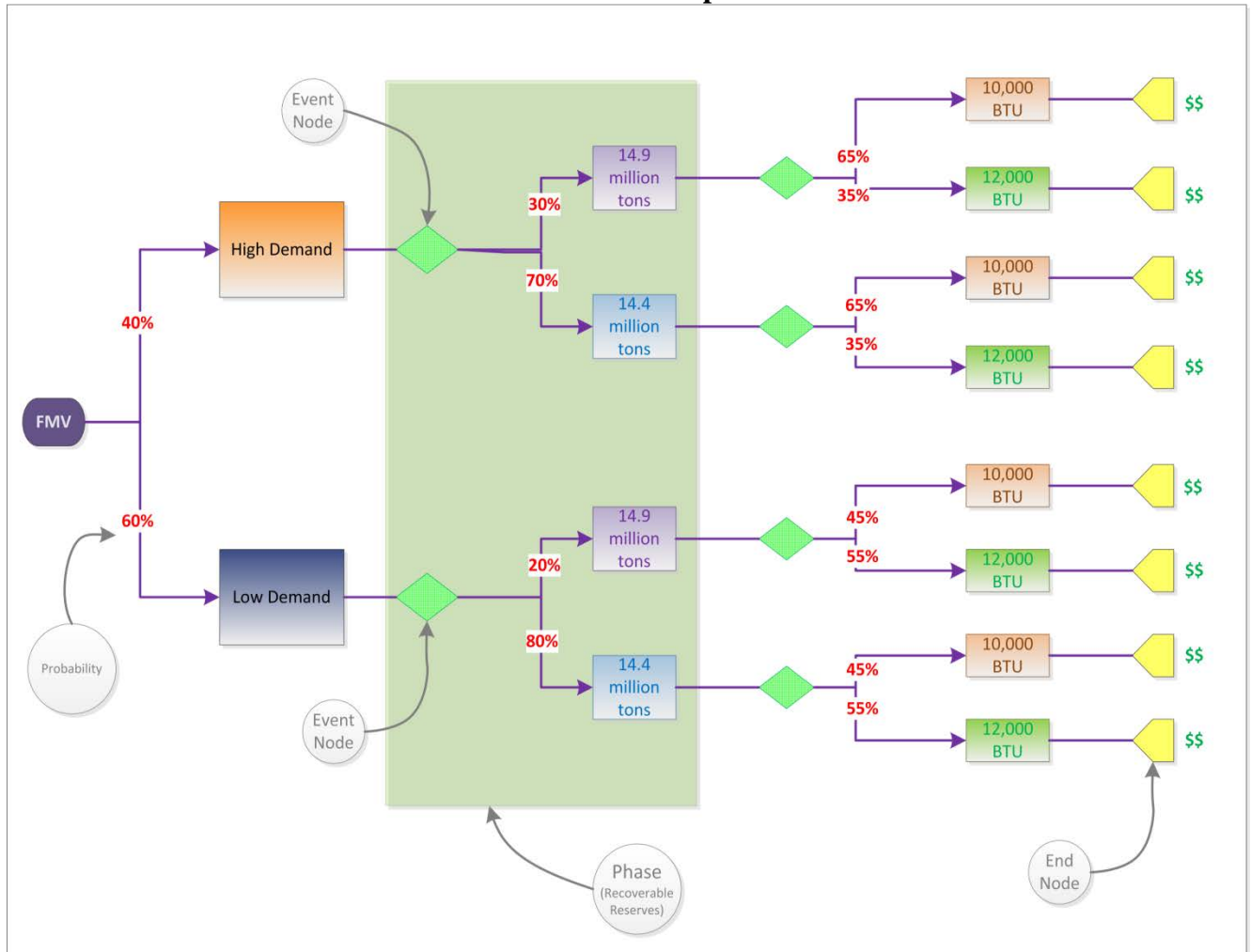

4.8. Computer Models for Mineral Property Valuation

4.8.1. Mine Simulation and Costing Algorithms

Mine simulation and costing algorithms are available to assist the analyst in developing annual capital and operating cost estimates. Surface and underground coal mining cost computer models have been developed which provide procedures for estimating detailed capital and operating costs and other requirements of proposed or existing mine operations. The costing algorithms are essentially accounting procedures that contain several distinct steps for establishing production costs.

An engineering process model consists of algorithms that model the discrete activities associated with coal production. These activities are defined by the mine plan and mine technology chosen for the property development. Using this information, an engineering process model can generate equipment requirements, labor requirements, material requirements, and support requirements for the production activity. Capital and operating costs are developed from these requirements. These costs are used to generate annual cash flow from which a net present value

of the income stream can be determined.

4.8.2. DCF Computer Programs

The complexity of the DCF method for mineral property valuation has led to the development of specialized computer programs. A DCF computer program simulates the accounting procedure used to determine annual cash flows of a mineral project and to develop a NPV of the cash flow stream. Generally, the user provides the input data required by the program to perform the DCF analysis. However, the DCF program may be combined with mine simulation and costing algorithms to provide a complete formulation of the mine economic evaluation. Uncertainty in input values may be handled through sensitivity analysis in which key input parameters are varied selectively through their range of probable values.

4.8.3. Monte Carlo DCF Computer Program

The need to incorporate uncertainty in the valuation process resulted in the refinement of DCF computer models to permit Monte Carlo simulation. Uncertainty in input values is handled by the Monte Carlo simulation program by using assumed probability distributions of input variables, rather than point estimates. The simulation randomly samples each variable from its probability distribution and performs the DCF calculation. Repeated application of the simulation results in a frequency distribution of the net present values from which an expected value of NPV can be determined.

In Monte Carlo simulations, some combinations of input values may yield negative NPVs. A negative NPV indicates either a reduced rate of return on investment (i.e., a rate of return less than the discount rate used in the simulation) or an actual loss, depending on its magnitude. In performing an evaluation, negative values will be included in the NPV distribution; however, they will be accounted for by substituting the pre-development cost whenever there is a negative NPV.

4.8.4. Other Additional Modeling Software

The use of other modeling software requires an explanation of the software, the purpose of the software in the evaluation, and steps or precautions taken to validate the results from the software.

Special Considerations

Because of the uncertainty inherent in the income approach, an exhaustive search for similar comparable sales should be made prior to its use. The analyst must document the comparable sales search results and justify the necessity of moving to a different method. Sometimes comparable sale values can be used to bracket an income approach value, but only if the situations are truly similar.

Despite the flexibility offered in the hierarchal approach, the analyst may encounter a situation where the procedures discussed above might be inappropriate. The analyst has the flexibility to apply alternative methods to obtain an estimate of value if sufficient information is unavailable to credibly apply the procedures above, or if the situation requiring valuation does not readily fit the methods described.

If the analyst pursues methodologies other than the comparable sales and income approaches, then the following must be documented;

Why a FMV estimate could not be made using the comparable sales approach or the income approach?

How will the analyst determine FMV for the offered property?

What is the basis and justification for using the alternative approach?

Special consideration is the need to make unique adjustments, such as those for delayed payment of the bonus. In this case, the estimated FMV must be increased to reflect the additional value to the mine operator reflected in the delay in the payment of the bonus. This increase should be the discount rate times the amount delayed for the years of delay.

Chapter 5. Preparation of the Pre-Sale Valuation Report

5.1. Introduction

This section identifies the content and formatting requirements for coal evaluation reports. Each evaluation report must be consistent with these directions.

The evaluation report must address the following items to document an accurate coal evaluation:

- **Fair Market Value.**
The report must include a defined and well-documented analysis of pre-sale FMV estimate.
- **Qualified Evaluation Experts.**
The qualifications of all Mineral Valuation Experts (Refer to Chapter 2) who participated, or contributed, to the project must be included.
- **Clarity.**
The report must be presented in a manner that is comprehensive and understandable to internal and external audiences.
- **Sufficient Detail.**
The report must contain an adequate amount and quality of market data and information inclusive in the valuation process and final conclusions to determine the pre-sale FMV estimate. All data sources must be documented in the report.
- **Public Trust.**
Public trust is accomplished through structuring the final evaluation report to facilitate providing as much of the final valuation report as allowable under statute and regulation to the public and to using established methods and procedures to produce a comprehensive report.
- **Confidentiality.**
Similar to providing a final valuation report that will foster public trust, the final evaluation report must also effectively protect certain proprietary and confidential information obtained from operators, lessees, licensees, or permittees on Federal or Indian mineral leases, licenses, and permits from disclosure. Efficient organization of the evaluation report can aid in the protection of proprietary or confidential data. Proprietary or confidential information must be readily identified within the final valuation report.

5.2. Valuation Report

A written mineral Valuation Report is required with content that is commensurate with the complexity and detail necessary to adequately explain and support the pre-sale FMV estimate. Each valuation report must contain sufficient and defensible explanation, factual data, analysis and conclusions, exhibits and addenda, following the outline presented in this section.

5.2.1. Summary Page

The first page of the report summarizes the information and conclusions. It contains only brief descriptions of the information presented in the report, including:

- **Tract Name and Adequate Property Description.**
Provide overview of the tract and its geographic relationship to towns, railroads, highways, and other mines in the area. The inclusion of maps is encouraged to illustrate geographical relationships. Include the county and State in which the tract is located.
- **Purpose of the evaluation.**
Provide a brief statement (generally one paragraph) of what is being valued. In most cases, the preparation of a pre-sale FMV estimate will be for the purposes of offering the

right to mine federally owned coal through a Federal coal lease.

- **Critical FMV information.**

A brief statement of the evaluation method(s) used (Comparable Sales Approach and/or Income Approach) and the date the evaluation was completed.

5.2.2. Evaluation Summary

List the pre-sale FMV estimate for the tract(s). The reported value(s) should be presented in total value and for comparison purposes as dollars per recoverable ton and dollars per acre.

5.2.3. Signature Page

This page should contain signatures of the responsible persons and reviewers. At a minimum, the report should be signed by:

- The Mineral Valuation Expert who prepared the report;
- The appointed external agency reviewer;
- The Deputy State Director delegated to overseeing Mineral Resources for that BLM State; and
- Others reviewers could be included as signatories on this page, for example if an internal peer review of the evaluation is conducted.

5.2.4. Table of Contents

A table of contents is required for all reports.

5.2.5. Introduction

The introduction provides an overview of the valuation. The introduction will explain how and why the valuation analysis began, the purpose of the valuation analysis, and discuss the general assumptions, directions, and guidance. The introduction must describe the assumptions and limiting conditions that are the basis of the evaluation.

5.2.6. Tract and Legal Land Description

This section provides a complete legal land description of the tract(s) being valued. If the legal property description is lengthy, include it as an appendix and refer to it in the text. At a minimum, document data such as:

- Subdivision;
- Tract identification or name;
- Section;
- Township;
- Range;
- Meridian; and
- Total acreage and, if different, the acreage used to estimate FMV.

A map or graphic illustration is encouraged to supplement the legal land description of the tract.

5.2.7. Tract Data

Discuss all pertinent information about the evaluated tract(s). At a minimum, include a discussion of:

- The total acres, coal acres, economically recoverable coal acres;

- The location in region and proximity to transportation and coal markets;
- The tract type (e.g., new production, captive to an existing mine);
- The geology (e.g., general geology, site geology, drainage, mining geology, coal reserves, etc.);
- The coal quality and marketability (i.e., Btu/lb, % moisture, % ash, % sulfur, % volatile matter, % fixed carbon);
- A summary of engineering report (describe mine engineering and cost analysis for the tract);
- A summary of economic report (describes the economic outlook, marketability, etc. for the tract);
- Any supporting documentation (e.g., maps, references, sources, data used to defend/justify value); and
- Other qualities that can effect value, when applicable (e.g., high sodium).

5.2.8. Analysis

The analysis section discusses the procedure for determining the estimated value of the Federal coal property. Refer to Chapter 4, Evaluation Data Requirements and address all applicable topics appropriately. If a topic is not relevant or warranted to be included in the analysis, then explain its exclusion in a clear and concise manner.

5.2.9. Overview

An overview of the coal property valuation includes:

- A summary of the scope of work to evaluate the property;
- A discussion of the methods for obtaining data (the type and quality of available data will assist the analyst in determining the use of the most appropriate method or methods);
- A description of the selected evaluation approach or approaches used and the evaluation approaches that were not used, including the reasoning (both the reasons for selecting the method and the reasons for rejecting alternative approaches are clearly articulated);
- An explanation of the reconciliation between the comparable sales value, and the final recommended pre-sale FMV estimate.

5.2.10. Value Estimated by the Comparable Sales Approach

All comparable sale transactions used must be confirmed by persons having knowledge of the price, terms, and conditions of the sale. An explanation of how each comparable relates to the tract being evaluated must be included.

Several general considerations should be included in the analysis process:

- All data considered in the valuation process should be discussed (e.g., comparable sale transactions that may not have been included in the valuation). An explanation must be provided for including or excluding sales from the reporting process.
- All sales investigated (including sales subsequently rejected) having a reasonable degree of comparability are to be included. Each sale is included for direct, detailed comparison.
- Comparable sales must be clearly and consistently identified to permit cross reference with comments made in the report.
- Support must be developed for an adjustment made in the valuation process. The characteristics that lead to an adjustment are to be established.

- Comparisons are usually made on a sale basis, rather than a characteristic basis. Discuss each sale fully and consider all differences before proceeding to the next sale. Complete the discussion of each sale by considering the characteristics leading to the adjustment and conclude with an overall comparison with the tract being appraised.

5.2.11. Data Acquisition

Describe all efforts to acquire data and the sources from which raw data were obtained, including how the data were selected and verified.

Documentation of data sources must be presented in a manner that would allow the reviewer to duplicate data acquisition. The direct comparison of data must be documented, including a narrative that will accompany a numerical comparison.

Identify the data type and essential facts relating to each comparable property. Document and describe the qualitative and quantitative differences between the comparable and the offered tracts.

All data records, supporting data, and documentation must be maintained in files at the BLM offices in case of audit. Refer to the BLM records retention policy for how long these records must be maintained. The files will contain all documentation pertaining to the coal evaluation and supporting its conclusions. The files may include maps, transaction documentation, telephone conversations, memos, and any other pertinent information.

5.2.12. Data Analysis

The pre-sale FMV estimate can be determined by the comparable sales approach using unadjusted comparable transactions, adjusted comparable transactions, or regression analysis. The considerations that resulted in the selection of a particular valuation procedure must be documented and discussed. If an unadjusted comparable is used, describe the supporting rationale for basing value on an unadjusted selling price. If an adjusted comparable transaction is used, present the data that supports the need for an adjustment.

5.2.13. Comparison Factors

Various mineral property characteristics are recognized by the market as influencing value. These factors should be identified, discussed, and analyzed to support for a comparable sale. Characteristics to be considered include the following items:

- Date of sale;
- Sale price;
- Lease market conditions;
- Produced coal market prospects;
- Total lease acres;
- Total coal acres;
- Average coal thickness;
- Average overburden thickness;
- Average stripping ratio;
- Recoverable coal resource estimate;
- Coal quality;

- Transportation and marketing;
- Lease terms including:
 - Royalty rates;
 - Payment terms;
 - Items sold; and
- Other comparable market characteristics that are indicative of value can be included in an analysis when supported by a complete description and justification.

5.2.14. Adjustments

An adjusted transaction accounts for differences in the characteristics between the comparable property and the offered tract. Discuss the differences in tract characteristics that require adjustment. Show how these differences are incorporated into the adjustment estimation process and include a discussion of the arithmetic or proportional adjustment procedure.

5.2.15. Reconciliation of Comparable Values

If multiple estimates of value are reconciled into a single indication of value, then discuss the reconciliation method and the rationale for assigning estimated weights (if used).

5.2.16. Value Estimated by Income Approach

Include and discuss adequate factual data that supports the analysis. The present value of net income method must be explained in narrative form and supported by a statement of sources and factors that include:

- **Data Acquisition, Selection, and Documentation.**

The efforts to acquire data and the sources from which the data were obtained must be described. Include a discussion of how the data was collected and verified. Discuss the rationale for selecting specific data elements. The data acquisition should be documented in such a manner that data acquisition may be duplicated. All records and supporting documentation should be maintained in auditable files at the responsible or delegated BLM office. The files should contain all documentation pertaining to the evaluation and supporting its conclusions. The files may include maps, names, telephone conversations, and any other pertinent information.
- **Mine Plan.**

The development of the mine plan must be described and supported. Refer to the tract and mine characteristics and regional mining methods to support the mine type, production rate, equipment selection, manpower requirements, and other pertinent factors. Any development considerations identified by the applicant for the tract should also be considered.
- **Marketing.**

The market potential for coal from this lease should be described and supported. Regional supply and demand, development timing, lease specific market opportunities, coal quality, coal prices, and other relevant information should be explained. Make sure to include in the analysis and discussion the potential for marketing this coal in international markets.
- **Estimated Production Costs and Revenues.**

The method for developing mine production costs must be described and documented. Include an explanation of the model(s) used and any input requirements. Production

revenues must be estimated from coal prices and production rates.

- **Capitalization Technique.**

The DCF calculation methods used should be discussed. Describe the input requirements and discuss how they were developed for the analysis. If a probabilistic method is used, discuss how probability weights, scenarios, timing, or Monte Carlo inputs (distributions and variances) were developed.

- **Summary and Indication.**

A summary of the basic steps and the final market value indication from the income approach must be included following the income approach narrative.

- **Exhibits or Addenda.**

All exhibits needed in the mineral property valuation process, in addition to those used in the body of the report, should be included. Detailed data and information pertaining to the property or other important valuation factors that are too lengthy for the body of the report or that distract from a coherent presentation should be placed in this section. Other supporting reports that have been cross referenced should be included as an appendix.

5.2.17. References (Source Citation Format)

All grammar and syntax, the citations for all bibliographic sources, the accepted style and use of abbreviations, signs, and symbols, and preparation of tables, maps, and illustrations should follow the guidance found in *Suggestions to Authors of the Reports of the United States Geological Survey*, (7th Ed., 1991, or later). http://www.nwrc.usgs.gov/lib/lib_sta.htm.

Alternatively, the Geological Society of America (GSA) Reference Guidelines can be found at http://www.geosociety.org/pubs/documents/GSA_RefGuide_Examples_000.pdf.

Chapter 6. Review of the Pre-Sale Estimate FMV

6.1. Introduction

The third party review ensures conformance to accepted valuation procedures, as delineated in Department Manual (DM), *Office of Valuation Services*; 112 DM 33; and this Handbook (BLM H-3073-1), to determine that the coal valuation is consistent with this guidance. The reported estimation of value must be adequately supported through the methods, reporting, analyses and conclusions to the extent that the valuation estimate can be independently verified.

6.2. Completion and Transmittal of the Pre-Sale FMV Report

All members of the ET will participate in developing and editing the pre-sale estimate of value report(s). Once the pre-sale FMV estimation report(s) are completed, the Mineral Valuation Expert will sign and date the pre-sale evaluation report(s) and submit it to the DSD, or alternate official designated by the DSD, for their signature. After the DSD signs the document(s), they will transmit the pre-sale FMV estimate report(s) by memorandum to the Division of Minerals Evaluation (DME), Office of Valuation Services for review.

The transmittal of the pre-sale FMV estimation report(s) to DME for review by DME must be in compliance with the requirements of Section 8.9 of this Handbook, Chain of Custody.

6.3. Report Review Standards

6.3.1. Comparable Sale Data

Review of pre-sale FMV estimate will include ensuring that all appropriate and necessary data concerning comparable sales was gathered and documented, including:

- Lease sale value and the terms and conditions of the lease for leases on non-Federal tracts that are useable for comparable sales;
- Information on the sale of privately owned coal lands; and
- Evidence and rationale supporting the use of comparable information.

6.3.2. Constraints

The review of the development constraints associated with the property must include the rationale identified in the supporting reports and recommendations of the ET. Development constraints can include, but are not limited to:

- Mine and air quality permit capacities;
- Mineral development conflicts;
- Boundary restrictions (roads, water, ownership, land use, etc.);
- Engineering constraints (roof or floor conditions, mine safety, public safety. etc.); and
- Environmental constraints.

6.4. Coal Valuation Review Procedures

The DME will analyze the arguments presented in the pre-sale defensible valuation report and make an assessment of validity by determining if:

- The valuation process was followed;
- Work was completed to an acceptable professional standard; and
- The conclusions and results are consistent with the requirements of this Handbook.

6.4.1. Supporting Documentation Review

All valuation documentation will be reviewed to ensure that all conclusions are adequately supported. The reviewer will ensure:

- Each substantive conclusion is supported by data and analysis;
- References to supporting data are adequately documented; and
- The appendices include material that are relevant to the valuation report and that support its conclusions.

The reviewer will document the evaluation of supporting information and data. If the reviewer determines there is insufficient documentation to support the valuation conclusions, the reviewer will return the report to the DSD and ET for correction.

6.4.2. Document the Pre-sale Valuation Report Review

The reviewer will provide a written memorandum concerning the pre-sale valuation report that indicates the scope of the review, the conclusions of the review, and recommended actions prior to the lease sale. The reviewer's memorandum will be attached to the pre-sale valuation report as a part of the final report. The full valuation report and signed reviewer's memorandum will be returned to the DSD.

The approved pre-sale FMV is the value that the DME, after the conclusion of their review, has accepted as an accurate, well-documented pre-sale FMV estimate.

An illustration of the signature and arbitration process is provided in Figure 6.1.

6.5. Arbitration Team

Unresolved differences between the ET and the external reviewer may be elevated for assessment and resolution. If arbitration is necessary, the valuation report and all supporting documentation must be provided, consistent with Section 8.9 of the Handbook, to the arbitration team for consideration. An arbitration team is typically composed of the BLM State Director and the DME Chief, and may include collaboration with the BLM Director and OVS Director.

The assessment must be a comprehensive review that is focused on achieving program goals and assuring public confidence. The arbitration team must consider whether:

- The input data was selected on a fair and defensible basis;
- The input data is comprehensive, reasonable and accurate;
- The valuation procedure was appropriate for the available data;
- Alternative methods might yield a substantially better estimate of value; and
- The valuation is a justified estimate of fair market value.

The decision of the Arbitration Team will be the final determination for both the BLM and the DME concerning the pre-sale FMV estimate at issue.

An illustration of the signature and arbitration process is provided in Figure 6.1.

6.6. Lease Offer

A competitive lease sale cannot be held, and a lease modification cannot be offered to the applicant, until the DME has concurred with the pre-sale FMV estimate.

**Figure 6.1
Review and Signature Flow Diagram**

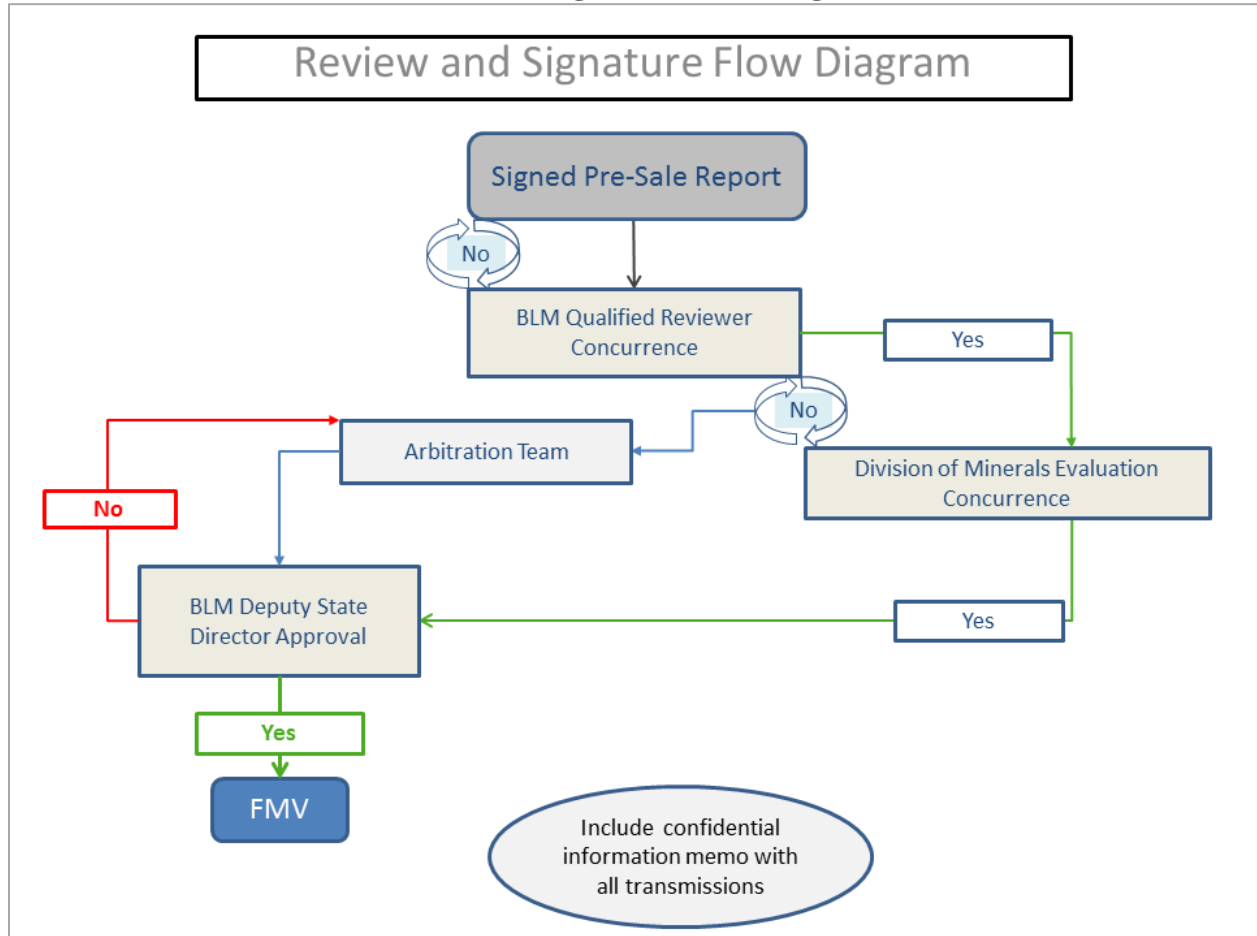

Chapter 7. Post Lease Sale Process

7.1. Sale Panel

The Sale Panel will review the bids in comparison to the pre-sale FMV estimate. Chapter 4, Lease Sale Procedures, of BLM H-3420, Competitive Coal Leasing, provides guidance concerning post-sale processes for competitive lease sales, including formation and duties of a Sale Panel.

7.2. Screen Bids for Minimum Qualifications

The Department of the Interior is authorized to accept or reject sealed bids pertaining to a competitive sale of a Federal coal lease tract. In evaluating the bids, the Sale Panel will screen all bids to determine if they qualify for further consideration.

For a bid to qualify for further consideration, the bid must satisfy all of the following criteria:

- The bid meets or exceeds the minimum bid found at 43 CFR 3422.1(c)2;
- The bidder passes all the qualification requirements delineated in 43 CFR Subpart 3472; and
- There is no indication of collusion in the bidding of the coal lease tract(s).

The Sale Panel subsequently reviews the bids passing this initial screen to determine if they meet or exceed the pre-sale FMV estimate. If a Sale Panel disagrees with the pre-sale FMV estimate that the DME has reviewed and with which the DMR has concurred, the Sale Panel will send the pre-sale report back to the ET and the ET will repeat the pre-sale FMV estimate approval process. (Figure 6.1).

7.3. Bid Acceptance Criteria

The bid acceptance criteria are shown in Table 7.1. A bid that has met or exceeded the pre-sale FMV estimate, and the bidder of which has met all qualification requirements, are “countable” bids for the post-sale analysis.

A tract, which received two or more countable bids and for which the Sale Panel has recommended to the SD acceptance of the highest bid as the fair market value for the tract, may also be used as post-sale comparable information.

**Table 7.1
Bid Acceptance Criteria**

| | |
|--------------------------|--|
| If a tract receives: | Then the Sale Panel will recommend to the SD to: |
| 2 or more countable bids | Accept the highest bid as FMV and reject other bids. |
| 1 countable bid | Accept the countable bid as FMV and reject other bids. |
| No countable bids | Reject all received bids. |

7.4. Post-Sale Valuation Report

The Sale Panel will prepare a post-sale report to document the post-sale analysis and

recommendations. The report will document all factors that were considered by the Sale Panel in the formulation of a recommendation to the SD to accept or reject a bid. For example, if the pre-sale FMV estimate is to form the basis for bid acceptance or rejection, the valuation procedure from which the pre-sale estimate was determined should be included or referenced in the post-sale valuation report. The post-sale report will be reviewed by DME and designated Deputy State Director for conformance to the coal valuation guidance. A public version of the report will be prepared by redacting or removing proprietary material. Refer to Section 8.7 of this Handbook, FOIA and Confidential, Proprietary Information, for more information concerning confidential and proprietary information.

7.5. DME/OVS Closure Memorandum

For a lease or lease modification that had a pre-sale FMV estimate determined in accordance with this Handbook, the SD, or person delegated by the SD, will provide a written memorandum to the DME/OVS with 30 days after:

- The issuance of the lease or lease modification;
- A decision to reoffer the lease or lease modification; or
- A decision to close the lease or lease modification application without issuance of a lease or lease modification.

The memorandum will describe or include as applicable:

- A summary of the bid value, the bidders name, and a notation of each bidder's qualifications pursuant to 43 CFR Subpart 3472, for all bids received from a competitive coal lease sale;
- The bonus value accepted for the lease or lease modification and the rationale for acceptance;
- If no bids are accepted, the rationale for not accepting any bid;
- The tentative date for a reoffer sale and the rationale for the reoffer;
- The rationale for closure of application for the lease or lease modification;
- A copy of the Sale Notice that was published in the Federal Register for a competitive lease sale; and
- A copy of the lease or lease modification that includes all terms and conditions.

Chapter 8. Proprietary and Confidential Information

8.1. Transparency

While much of the data and information used to develop a pre-sale estimate of value have proprietary and confidential characteristics, it is the policy of the BLM that the Federal coal leasing processes are as transparent as the law and regulations allow. To this end, consideration must be given while developing reports that support FMV estimates to the ease with which sensitive, confidential, and proprietary data can be redacted to provide publicly available documents. It is not acceptable to redact an entire document. Further, consideration should be given to timely posting public versions of FMV related documents prominently on publicly available web sites after a successful lease sale, consistent with law and regulation.

8.2. General Requirements

The BLM office staff must be aware that certain information obtained from operators, lessees, licensees, or permittees on Federal or Indian mineral leases, licenses, and permits can be proprietary and confidential, and appropriate security measures must be taken. The Evaluation Team (ET) and the project manager must be knowledgeable of and follow the procedures specified by regulations at 43 CFR Part 2 and BLM Manual 1278, External Access to BLM Information. Table 7.1 provides an overview of the various authorities that pertain to obligations for the protection of proprietary and confidential information.

Table 8.1
Authorities for Protection of Proprietary and Confidential Information

| Authority | Description | Citation |
|----------------------------------|---|---------------------------------------|
| Mineral Leasing Act, as amended. | Geologic data and information related to FMV before a lease sale. | 43 C.F.R. Part 2, Appendix B. |
| Standard Coal Lease Form. | Information collected under the requirements of the lease will generally be closed to inspection by the public in accordance with the FOIA, 5 U.S.C. 552 (b)(4). If a formal request is made for such information under FOIA, the BLM would make a determination whether the information sought qualifies for exemption from release to the requester in accordance with the provisions of 5 U.S.C. 552(b)(4) and 43 CFR Part 2, Subpart C. | BLM Form 3400-12, Part II, Section 6. |
| Trade Secrets Act. | Penalties for disclosure of third party proprietary and confidential information. | 18 U.S.C. 1905 |

| Authority | Description | Citation |
|---|---|---------------------|
| Indian Mineral Development Act of 1982. | All of the BLM's information is proprietary and confidential information of the Indian mineral owner. | 25 U.S.C. 2101-2108 |
| Freedom of Information Act | Provides standards for public access to public records. | 5 U.S.C. 552 |

8.3. The Mineral Leasing Act, as amended

The Mineral Leasing Act, as amended, provides specific protections for information that is collected under, or required by, the Act. Refer to 43 CFR Part 2, Appendix B, for specific requirements. The information protected under this provision includes:

- Data collected as authorized by an exploration license until either a lease is issued for the same area, or until the BLM has determined that making such data available to the public will not damage the competitive position of the licensee (30 U.S.C. 201(b)(3));
- Exploration data acquired from commercial sources under the authority of 30 U.S.C. 208-1 or 30 U.S.C. 351-360;
- Proprietary information obtained from commercial sources that are not under contract with the United States Government;
- Proprietary information provided by other Federal agencies under the authority of 30 U.S.C. 208-1 or 30 U.S.C. 351-360; and
- Prior to a lease sale, the BLM's FMV determination of coal to be leased and comments submitted to the BLM by the public with respect to such value that are identified by the public submitter(s) as proprietary or confidential information.

8.4. Coal Lease Form (BLM-3400-12)

In some cases information obtained from current lessees could be used in evaluation of a proposed coal lease tract. Section 6 of the standard lease form (BLM-3400-12) also establishes a contractual obligation for the BLM to maintain information collected under the requirements of this section of the lease and to not allow inspection by the public in accordance with the FOIA (5 U.S.C. 552). Refer to Section 7.7. Section 6 of Part II of the standard coal lease form (BLM 3400-12) requires the lessee to provide:

- Statements showing the amounts and quality of products removed and sold from the lease, the proceeds therefrom, and amounts used for production purposes or unavoidably lost;
- Access to all premises, books, accounts, maps, and records relative to operations, surveys, or investigation on or under the leased lands; and
- Access to copying of documents reasonably necessary to verify lessee compliance with terms and conditions of the lease.

8.5. Penalties for the Unauthorized Release of Proprietary or Confidential Business Information and Violation of the Trade Secrets Act

The unauthorized disclosure of information found to be proprietary or confidential information under FOIA, 5 U.S.C. 552(b)(4) and 43 CFR Part 2, Subpart F, Appendix B is prohibited. The

release of confidential, proprietary information could potentially be a violation of the Trade Secrets Act (18 U.S.C. 1905)(Refer to 43 CFR 2.23(j)). A violation of the Trade Secrets Act could potentially subject BLM employees to criminal penalties and liability. The Trade Secrets Act states:

Whoever, being an officer or employee of the United States or of any department or agency thereof, any person acting on behalf of the Federal Housing Finance Agency, or agent of the Department of Justice as defined in the Antitrust Civil Process Act (15 U.S.C. 1311–1314), or being an employee of a private sector organization who is or was assigned to an agency under chapter 37 of title 5, publishes, divulges, discloses, or makes known in any manner or to any extent not authorized by law any information coming to him in the course of his employment or official duties or by reason of any examination or investigation made by, or return, report or record made to or filed with, such department or agency or officer or employee thereof, which information concerns or relates to the trade secrets, processes, operations, style of work, or apparatus, or to the identity, confidential statistical data, amount or source of any income, profits, losses, or expenditures of any person, firm, partnership, corporation, or association; or permits any income return or copy thereof or any book containing any abstract or particulars thereof to be seen or examined by any person except as provided by law; shall be fined under this title, or imprisoned not more than one year, or both; and shall be removed from office or employment.

Both the BLM analyst and the BLM manager may each be potentially, personally liable if proprietary or confidential information subject to protection is found to have been released by them. Therefore, the responsible BLM office must strictly follow the procedures established by 43 CFR Part 2, Subpart F and Appendix B, and other applicable BLM guidance when requests for disclosure of potentially confidential or proprietary business information are submitted by the public. The BLM staff should consult with the DOI Office of the Solicitor and BLM FOIA staff in addressing requests for the disclosure of such information.

8.6. Indian Lands

The BLM protects all Indian records concerning minerals under an approved Indian Mineral Development Act Agreement as proprietary and confidential information of the Indian mineral owner. This confidentiality requirement applies even though comparable, non-Indian records would be considered public information on Federal lands.

8.7. FOIA and Confidential, Proprietary Information

The DOI regulations at 43 CFR Part 2 and Appendix B to 43 CFR Part 2, which describe the exemption from disclosure provided by FOIA, 5 U.S.C. 552(b)(4), provide that trade secrets and commercial or financial information submitted by a person or entity outside the United States Government are potentially privileged and confidential and exempt from release under the FOIA. The types of material submitted and gathered from operators on Federal mineral leases, licenses, and permits are considered to be trade secrets and commercial or financial information, and are subject to protection from disclosure as proprietary and confidential information in accordance with the above regulations and statutory citations. Note that 43 CFR Part 2 does not address all items that might be considered proprietary. Therefore, caution should be used at all times when

handling or storing information that may be proprietary and confidential. The ET and project manager must consult with BLM's FOIA specialists and the Office of the Solicitor concerning the status of any document that may have proprietary or confidential content and, thus, subject to potential protection from disclosure to the public.

The FOIA, as amended, requires agencies to provide agency records to requesters, except for material that is exempt from disclosure. Exemption means one or more of the FOIA's nine statutory exemptions, found at 5 U.S.C. 552(b)(1)–(9). For example, FOIA Exemption 3 allows the withholding of information prohibited from disclosure by another federal statute such as the Mineral Leasing Act of 1920 (Refer to 43 CFR 2.70). Exemption 4 allows withholding of trade secrets and commercial or financial information obtained from a person that is privileged or confidential, and Exemption 5 protects privileged agency documents. While FOIA Exemption 9 protects from disclosure geological and geophysical information, it only pertains to information related to wells. The recent decision in *NRDC v. DOI*, No. 13 Civ. 942 (PAE) (S.D. NY) (August 5, 2014) clarified that Exemption 9 does not include geologic and geophysical information from drilling cores and boreholes for coal exploration and not related to fluid mineral extraction wells. All nine exemptions must be considered to see if one or more exemptions apply to the information requested.

8.8. Security

In addition to maintaining proper security measures to protect case files with proprietary or confidential information, an ET must clearly notify information technology, secretarial, mailroom, and clerical personnel that all mail or correspondence concerning Federal and Indian mineral leases and permits must be properly handled to protect prospectively proprietary or confidential information. Proper control over proprietary or confidential information and files can only be accomplished by locating the proprietary or confidential material separately from those material and files traditionally located in "Central Files" (also known as "Lease Case File") and restricting access to the files that contain proprietary or confidential information. This applies whether the information or "file" is paper or electronic. Other applicable file and record retention guidance can be found in BLM MS-1220, Records and Information Management, and in BLM MS-1278, External Access to BLM Information.

These "best management processes" will help assure continued data security and must be used:

- The pre-sale estimate of value must not be discussed outside of the official BLM;
- Meetings or conversations where sensitive evaluation data are discussed will be held or carried out in a secure area and in such a manner that personnel without a "need to know" are prohibited from hearing such discussion or having access to such data; and
- All sensitive and proprietary data must be locked in an approved secure filing cabinet or vault when the data are not actually required for analysis and discussion purposes.

8.9. Chain of Custody

The sensitive pre-sale FMV estimate and all proprietary data used in the supporting analysis must be properly safeguarded by anyone with access to this information. Therefore, complete records must be maintained about all individuals who have access to any of the information used or developed for completion of a pre-sale FMV estimate, including all supporting data, reports, and conclusions.

Only those BLM and DME employees with a “need to know” will be granted access to the sensitive, confidential, or proprietary data. The DSD will determine who has access to this information. Records must be maintained within the project case file or record that document:

- Who has had access to the sensitive, confidential, or proprietary data;
- The term or duration each person had access, including perpetual access; and
- The rationale for each person’s access.

Access to sensitive, confidential, or proprietary data by non-BLM personnel may be granted in special circumstance. Every case must be evaluated on its merits and there is no assurance or presumption that access will be granted. In all cases, records must be maintained in the official case file that document:

- Who was granted access;
- Why each person was granted access;
- What information and data the person can access;
- That non-BLM personnel obtaining access are informed of the restrictions to the data and information provided; and
- That non-BLM personnel sign, date, and return an Information Security Agreement, BLM Form 1273-2a, to acknowledge that they understand the restrictions on the information provided and that they will comply with BLM confidentiality requirements.

A sample letter offering access to BLM’s sensitive, confidential, or proprietary data to a non-BLM person or agency is provided in Figure 8.1. The requestor of confidential and proprietary information must return a completed Information Security Agreement, BLM Form 1273-2a, to the BLM before the requested information can be provided. All completed forms must be retained in the official case file.

Figure 8.1

Sample Letter for Transmittal of Proprietary and Confidential Evaluation Information

Date mm dd yyyy

Memorandum

To: Name
TitleFrom Name
Deputy State Director, Mineral and Lands, local State Office

Subject Transmittal of Proprietary and Confidential Evaluation Information

This is in response to your request dated mm-dd-yyyy for information concerning the evaluation completed for tract XYZ. Your request is necessary for you to complete a special analysis that is described here.

The documents that we will provide contain confidential and proprietary information. The information in these documents is protected from disclosure and any release would cause harm to both the submitter of the information and the Government. The geology and engineering reports were prepared using confidential and proprietary business information submitted by the applicant to the BLM. The economic analysis and pre-sale evaluation were prepared by the BLM using confidential third party business information and with confidential business information provided by the applicant. Public disclosure would place private submitters at a competitive disadvantage. In addition, public disclosure of the economic and evaluation data would cause substantial harm to the Government by creating an unfair bidding process, possibly altering what would otherwise be competitive good faith independent bids for pending coal lease sales as well as bids at future sales for adjacent tracts.

The BLM will require your acknowledgement of the confidential and proprietary character of the information that will be provided and your agreement to protect this information from any release before we forward this information to you. We have enclosed BLM Form 1273-2a, Information Security Agreement, for you to complete and return to our office. Upon receipt of your correctly completed BLM Form 1273-2a, we will forward the documents identified on your completed Form 1273-2a.

Contact informationThank you
Signature

Glossary

- A -

Active Markets: A market characterized by growing demand, a corresponding lag in supply, and an increase in prices.

Approved Pre-Sale Fair Market Value: The pre-sale FMV estimate that a third party reviewer has concurred to as defensible.

- B -

Bracket: A probable range of values obtained from the comparative sales.

- C -

Capital Cost: Costs for the acquisition of land, permits, new equipment, or large repairs of existing equipment for which tax considerations of depletion and depreciation must be considered.

Cash Flow: The cash flow is the amount remaining after operating expenses, royalties, taxes, insurance, and overhead have been subtracted from the gross revenue. The cash flow includes non-cash allowances that are considered for tax calculations such as depreciation and depletion.

Coal Region: Refer to 43 C.F.R. 3400.5 and Federal Register Volume 44, page 65196 and 65197 (November 9, 1979).

Competitive Markets: Markets in which a large numbers of producers compete with each other to satisfy the wants and needs of a large number of consumers.

Consumption Markets: A market made up of customers that consume or use severed coal to provide other goods and services, such as burning in a power plant to generate electricity.

Cost Element: The cost of a resource or input consumed by an activity, such a mining coal, coal transportation, or coal processing.

Countable Bid: A bid that meets or exceeds the pre-sale FMV estimate and the bidder of which has met all qualification requirements.

- D -

Defensible: Documentation of work that leads to a result or conclusion to the extent that an independent entity can recreate the work and come to the same or a similar result or conclusion.

Discount Rate: An interest rate used to convert future payments or receipts into an equivalent present value.

Discounted Cash Flow: The procedure in which a discount rate is applied to a set of projected cash flows to determine an equivalent value in terms of the values current value.

Defensible Valuation Report: A report that must contain or reference all supporting facts and data, as well as document and explain assumptions, analyses and conclusions to the extent that the valuation estimate can be independently verified.

-E-

Evaluation Team (ET): A team of BLM employees with the necessary skills to complete an evaluation to determine a pre-sale FMV estimate. Under specific criteria specialized skills may be supplemented with contracted services. Chapter 2 of this Handbook provides additional details.

- F -

Fair Market Value (FMV): The amount in cash, or on terms reasonably equivalent to cash, for which in all probability the coal deposit would be sold or leased by a knowledgeable owner willing, but not obligated to, sell or lease to a knowledgeable purchaser who desires, but is not obligated to, buy or lease the coal deposit.

- L -

Lease: An agreement made under applicable law whereby real property to which the Federal government, an Indian tribe, or an Indian allottee holds title has been made available by the government to someone to occupy or otherwise use for the purpose of coal extraction and development in return for payment of specified compensation to the Federal government as owner of the property or acting on behalf of the Indian tribe or allottee. This term includes agreements for authorized coal extraction from all Federal and Indian underground and surface coal tracts.

Lease-By-Application (LBA): Procedure whereby the public nominates a particular tract of coal for competitive sale

Load-out: The location where severed coal is put in a transportation vehicle for shipment to the coal purchaser or consumer. Commonly, the coal is weighed at the load-out for freight rate and commerce purposes. The load-out is commonly the point of sale where value for royalty is determined.

-M-

Market Value: The amount that a competitive market has shown that can be reasonably expected for the sale of a specified commodity.

Maximum Economic Recovery (MER): The standard for Federal coal recovery which requires, based on standard industry operating practices, that all profitable portions of a leased Federal coal deposit must be mined. At the times of MER determinations, consideration will be given to:

- Existing proven technology;
- Commercially available and economically feasible equipment;
- Coal quality, quantity, and marketability;
- Safety, exploration, operating, processing, and transportation costs; and
- Compliance with applicable laws and regulations.

The requirement of MER does not restrict the authority of the BLM to ensure the conservation of

the recoverable coal reserves and other resources and to prevent the wasting of coal. Also Refer to Section 1.5.2 of this Handbook for a detailed discussion.
Mining Unit (MU): Refer to Section 1.5.4 of this Handbook for a detailed discussion.

-N-

Net Back: For the purposes of determining royalty, the reported sales value of the coal less transportation charges that are paid by the mine operator for expenses to transport coal from the mine to any contractually agreed transfer location between the mine and the coal consumer.

Net Present Value: The total (or net) value of a series of values (such as expenses, revenues, or cash flow) over time (for example, annual cash flow) that is expressed in terms of the value of money today at a specified discount rate. The future value of expenses, revenues, or cash flow is converted to present value using a uniform discount rate.

-O-

Operating Cost: The cost associated with routine mine operations and repair and that are generally proportional to the amount of coal production. These costs can include labor, labor benefits, fuel, routine repairs, replacement parts, supplies, etc. Operating costs do not include fixed costs which are not proportional to coal production such as insurance or corporate overhead.

-P-

Present Value: The amount that would be required today, if invested over time at a discount rate, to realize an amount in future that is equal to the value of future revenues or expenditures.

Primary Factors: The break-up market value of all divisions of a company if the divisions were each independent and established their own market stock prices.

- S -

Sale Panel: As described in BLM Handbook 3420, Competitive Leasing, this is a panel of BLM personnel who will evaluate the bids received from a competitive sale.

Stripping Ratio: For surface mining, the ratio of the amount of overburden expressed in cubic yards that has to be mined or removed to unearth or expose one ton of coal.

- U -

Ultimate Maximum Recovery (UMR): Refer to Section 1.5.3 of this Handbook for a detailed discussion.

Appendix A: Defensibility of Linear Regression Analysis

The objective of a regression analysis is to find the most accurate equation to describe the relationship between a dependent variable and one or more independent variables (e.g., price of coal and physical characteristics of the coal—Btu, ash, sulfur content, NO_x content, etc.). A common solution is a linear regression or multivariate regression to identify and estimate the relationship between the dependent and independent variable(s). However, some precautions are needed to properly use linear regression (also known as Ordinary Least Squares, or OLS) and related techniques. OLS analysis is a useful analytical tool. To assist in construction of meaningful and accurate OLS equations, an analyst must be aware of the diagnostic tools and techniques described below.

1. Ensure the data set or sample size is adequate.

For statistically significant results that will withstand scrutiny, an OLS analysis must meet specific data requirements. "...the reliability of the estimates increases as the sample size increases... For an annual model, a sample of at least $20 + k$ data points is required. Here $k = k'+1$, and k' is the number of explanatory variables, and the number 1 represents the constant term in a model." *Regression Analysis: Modeling & Forecasting* George C. S. Wang, Chaman L. Jain Institute of Business Forecasting and Planning, 2003

2. Use Consistent, Representative, and Inflation-Adjusted Data.

Data points should be drawn from a range of values that is as broad as possible. For example, when using OLS to correlate data, physical characteristics of the coal or the coal price are considered data points and should be drawn from broad, industry wide data rather than from more focused data that is related to only lease modification or LBA (lease by application) transaction data. Great care is required to ensure that all data represent comparable transactions. The data that is used must be either:

- Drawn from contemporaneous information sources, or
- Corrected for inflation and other time-dependent variations.

The indices used to adjust for inflation must be appropriate to the data that is being adjusted. For example, when adjusting coal prices for coal used by utility power plants, the analyst should use the producer price index, not the consumer price index. One possible source for aid in determining the proper inflation-adjustment index is found at <http://www.house.leg.state.mn.us/hrd/pubs/priceindex.pdf>.

Data from different vintages of coal markets, or data from markedly dissimilar coal regions, should not be lumped together, unless it can be justified and the justification is documented.

3. Treating data points that are not within the primary data cluster(s).

A data set can contain data points that are outside of the primary data cluster(s). These are known as outliers. An analyst must decide whether or not to use or reject these outlier points when constructing OLS regression line. There are two issues of concern:

- Are the outlier data points valid, or should they be rejected when constructing an OLS regression line? An analyst must evaluate how much the outliers alter the slope and dependent axis (y-axis) intercept of the OLS regression line and thereby use professional

judgment to determine whether or not these outliers should be retained in the regression equation.

- An analyst must evaluate whether or not estimates derived from the OLS regression line are within the area defined by the data set that was used to construct the regression line. The analyst must also evaluate whether the regression line to be used to extrapolate values are beyond the region defined by the data set used to determine the OLS regression line. The validity of using the regression equation to extrapolate projections outside of the area defined by the data set can bring the validity of the entire analysis into question.

4. Scatter Plots.

A scatter plot is a useful method for examining data for empirical linear relationships. The scatter plot presents the data on a graph showing the location of the data points by plotting the independent (x-axis) value of the data point the dependent variable (y-axis) value. A linear pattern on a scatter plot is evidence of a potential linear relationship. If multiple equally likely lines can be fitted to a scatter plot using OLS, it is unlikely that a linear regression explains the relationship between the variables.

5. Independent Variables. If more than one independent variable is used, the variables must not be correlated with each other.

The existence of improper correlation between variables is known as [or called] multicollinearity, which is a condition that can misleadingly inflate the standard errors, thereby making some variables statistically insignificant, while they should be otherwise significant. If this condition occurs, the variables cannot be considered independent, which means the OLS regression equation is less defensible. As a rule-of-thumb there is a good chance that multicollinearity is a problem if the correlation coefficient (R) between the two independent variables is larger than the correlation coefficient of either or both independent variables with a dependent variable. The addition of an independent variable to the regression equation that is correlated with another independent variable does not give any more explanatory power to the regression than does using only the one independent variable. (See, e.g., Pindyck, R.S., and Rubinfeld, D.L., 1981, 2nd ed., *Econometric Models and Economic Forecasts*, p. 89).

6. Explanatory Power of Each of the Independent Variables.

All independent variables used in the OLS regression equation must contribute explanatory power to the equation. The beta coefficient measures the relative importance of each independent variable to the regression equation. A larger beta coefficient indicates the independent variable has a greater importance in explaining variation in the dependent variable. A common yardstick for accepting or rejecting independent variables is if the beta coefficient for each independent variable is significant at the 90th or 95th confidence interval.

7. Acceptable Fit of Regression Line and a Check on Whether or not the Proper Independent Variables have been Included in the Regression.

“Goodness of fit” is the measure of the closeness of the calculated OLS regression equation to the observed data points. The “goodness of fit” of the regression line must be above an acceptable level. A reasonable rule-of-thumb for a regression run on time-series data (i.e., data across several time periods) is a value of 0.80 or greater. By contrast, an acceptable R^2 for cross-

section data (i.e., data from a single time period) is 0.70 or greater. A value of 0.80 for an R^2 describing a regression equation, means that 80 percent of the variation in the dependent variable can be correlated by the observed changes in the independent variable. (Note: to be used properly, one must use the adjusted R^2 value, i.e., properly adjusted for the number of independent variables used and the degrees of freedom).

Adjusted R squared.

The R^2 is a statistic that will give some information about the goodness of fit of a model. In regression, the R^2 coefficient of determination is a statistical measure of how well the regression line approximates the real data points. An R^2 of 1.0 indicates that the regression line perfectly fits the data.

Adjusted R^2 is a modification of R^2 that adjusts for the number of explanatory terms in a model. Unlike R^2 , the adjusted R^2 increases only if the new term improves the model more than would be expected by chance. The adjusted R^2 can be negative, and will always be less than or equal to R^2 .

Adjusted R^2 does not have the same interpretation as R^2 . As such, care must be taken in interpreting and reporting this statistic. Adjusted R^2 is particularly useful in the Feature selection stage of model building.

Adjusted R^2 is not always better than R^2 : adjusted R^2 will be more useful only if the R^2 is calculated based on a sample, not the entire population. For example, if our unit of analysis is a State, and we have data for all counties, then adjusted R^2 will not yield any more useful information than R^2 .

8. Use of the F statistic as a measure of the validity of a multiple regression equation (and the significance of the R^2 statistic).

The F statistic is a test of whether or not one can reject the null hypothesis. The null hypothesis states that the explanatory (independent) variables do not explain the variation of the dependent variable. To have confidence that an OLS regression has statistical significance, and thereby allows the null hypothesis to be rejected, the F statistic must be large enough to permit statistically rejecting the null hypothesis. One common rule-of-thumb level of significance is to reject the null hypothesis where the F statistic is significant at the 90th confidence interval.

Appendix B: History of Federal Coal Fair Market Value Estimation

The Mineral Leasing Act of 1920, which changed procedures for the acquisition of coal mineral rights from outright sales to leases, motivated the development of guidance to facilitate consistent value estimations of Federal coal properties. Early efforts to ensure reasonable value were determined for Federal coal properties relied on the Federal Property and Administrative Services Act of 1949, under which coal in lands reported as surplus was disposed of by the General Services Administration. In 1959, the Bureau of the Budget [now the Office of Management and Budget (OMB)] established that fair market value should be obtained when federally owned resources are leased or sold.

Prior to 1970, the Department of the Interior (DOI) paid little attention to setting a value for coal leases. Competitive and noncompetitive leases were available at little cost, because it was thought that the Federal Government would receive a fair return through royalty collection. In 1971, the Conservation Division of the U.S. Geological Survey (USGS) adopted the "K-Factor" formula for evaluation. This was an empirical formula that considered the total thickness of minable coal beds, the Btu value of the coal, the coking quality, and the coal depth. The formula included a variable, K, which was determined by the USGS Area Mining Supervisor based on his judgment of market conditions and other factors. The K-Factor formula forced the Area Mining Supervisor to specifically consider important geological parameters. The formula was used for valuing a few leases.

Later, in 1971, the DOI issued an informal coal leasing moratorium to prevent speculation. This action was followed in 1973 by a formal moratorium on leasing, except for short-term leases that met specific criteria, while the DOI developed a new long-term leasing policy. In 1975, a programmatic environmental impact statement was released analyzing the proposed Energy Minerals Activity Recommendation System program. One of the goals of the new policy was the return of fair market value (FMV) for Federal coal lease tracts.

In response to criticism directed at evaluation procedures of the early 1970's, the DOI began in late 1975 the development of new coal evaluation procedures. The new method was based on the income approach using discounted cash flow (DCF) procedures. The development efforts were carried out by the USGS Conservation Division and included operational procedures and a computer program for DCF analysis. The DOI used the DCF computer program to develop estimates of FMV.

The economic evaluation was structured as a three-level process:

- Resource determination by the area geologist;
- Mining method and mine design by the area mining supervisor; and
- Costing and economic evaluation (including tract valuation) by the economic evaluation staff.

The results for each tract were assessed by a three-member committee that made a recommendation to the BLM State Director to be used in determining FMV.

Beginning in 1977, the DOI decided to provide an indication of its estimation of value when

offering leases. This took several forms between 1977 and 1980, including:

- Advertising leases at minimum bonus bids with royalty rate bidding;
- Advertising leases at minimum statutory royalty rates and variable bonus bids; and
- Offering the bidders a choice between these two options.

These published values, in effect, were the DOI's pre-sale estimate of value, and any bid at or above these amounts was accepted as FMV. In light of legal requirements and Federal goals and responsibilities concerning coal leasing and development, concern developed about the meaning of FMV.

In 1979, a Federal coal leasing FMV task force was convened to develop options for FMV, as well as policy and criteria for minimum acceptable bids. A Secretarial Issue Document (SID) was prepared concerning the definition of FMV, the definition of minimum acceptable bid determination for different tract types, and other policies related to Federal coal tract evaluation. The SID required that "fair market value for Federal coal leases should steer a course midway between seeking to maximize capture of economic rent and satisfying the minimum legal obligations." The SID also required that large and small tracts be evaluated differently and that FMV should be captured through the use of higher than regulatory minimum bids where appropriate, rather than elevating the royalty rates.

An Oversight Group was established to implement the SID and to set procedures for differentiating large and small tracts. Preliminary mineral appraisal and small tract determination procedures were implemented.

In 1980, a formal decision on small, high-rent tracts was issued. These tracts were divided into two types, and different procedures for evaluating minimum acceptable bids for each were recommended. These procedures were in effect from December 1980 to September 1982, with publication of interim procedures. The preference shifted in 1980 to the use of the comparable sales approach for FMV estimation as more sales data from Federal coal leasing became available.

As part of a DOI effort to streamline procedures, the USGS Conservation Division recommended the consideration of competition as an acceptance factor when determining FMV. In early 1982, the DOI developed procedures to allow the competitive market to have an input into determining FMV.

For the 1982 Powder River region lease sale, the final tract value estimations were determined after all bids had been examined. Pre-sale estimates of value were based on adjusted comparable sales. Monetary adjustments representing the cost and revenue impacts of physical differences between the subject tracts and the comparable tracts were made. In order not to preclude potential bidders, the pre-sale estimates of tract values were not released to the public. Instead, the tracts were grouped into four categories with a different entry level or floor bid for each category. The published entry level bids were based on cents per ton of recoverable coal, except for one category of \$25 per acre (the regulatory minimum). The guidelines that were adopted required the post-sale evaluation consider the pre-sale values, the competition at the sale, and discretionary special tract circumstances that were allowed to affect the bid acceptance decision.

Following the 1982 Powder River regional coal lease sale, a number of actions were taken by the DOI to further improve the coal lease evaluation procedures. In the summer of 1982, the Federal coal management regulations were revised to prescribe leasing by sealed bidding and a \$100-per-acre minimum bid. In September 1982, the DOI adopted interim lease sale procedures that called for competitive tracts to be offered at a minimum bid of \$100 per acre and non-competitive tracts to be offered at a minimum bid that would constitute a representative market value, but not less than \$100 per acre. FMV was to be determined after the sale using competition where it occurred and updated pre-sale comparative analysis where competition did not occur. The interim procedures removed any special circumstances from the recommendation to the sale panel and relegated them to comments on the recommendation.

In July 1983, procedures were revised for the Fort Union coal sale as follows:

- A dated and sealed pre-sale evaluation was prepared.
- No hints were given bidders as to the pre-sale value estimates; all leases were offered at a minimum bid of \$100 per acre.
- Tight security was instituted concerning the DOI's reservation prices and the number and identity of bidders until the bids were opened publicly.
- A post-sale bid evaluation occurred in which the acceptance of bids, if any, were based on the average of two or more substantive bids (of at least 25 percent of the pre-sale estimate) and the pre-sale estimate. Tracts accepted under this process became available as comparable tracts to be used, as appropriate, to estimate the value of tracts that did not receive two or more substantive bids. A complete sale panel decision document was required, and all reservation prices on tracts not sold remained confidential.

In 1985, draft guidance entitled, A Guide to Federal Coal Property Appraisal, was sent to the field offices. This guidance was successfully used by the Regional Evaluation Teams. In 1993, comments from the field offices were incorporated with the 1985 guidance to prepare the 1993 version of the H-3070-1 Handbook.

In 2013, two audits of the BLM's Coal Management program were completed by the DOI's Office of Inspector General (OIG)(CR-EV-BLM-0001-2012) (Final Report - June, 2013) and the Government Accountability Office (GAO)(GAO 14-140) (Final Report - December 2013).

The OIG provided 13 recommendations for corrective action and the GAO provided 8 recommendations. The OIG and the GAO reports have similar recommendations concerning the valuation of Federal coal property that include:

- Strengthen pre-sale value estimates with appropriate peer reviews;
- Determine if the office of valuation services can provide independent peer review;
- Assure export markets are considered in pre-sale value estimates;
- Revise guidance to encourage both comparable sales and income approaches to estimate pre-sale value;
- Specify the documentation needed for post-sale revisions in BLM's estimated value; and
- Strengthen internal controls and safeguards over the estimate market value records.

This Handbook addresses these recommendations.

The GAO and OIG audits included additional recommendations that were not directly related to the valuation of Federal coal property. These additional recommendations are acknowledged here for completeness. These additional recommendations are outside the scope of this Handbook and are therefore not addressed in this handbook.